

HD2402

**Photo-Radiometer / Dosimeter
for non-coherent artificial optical
radiations (A.O.R.) measurement**

ENGLISH

Our instruments' quality level is the results of the continuous development of our products. This can cause differences between the information written in this manual and the instrument that you have purchased. We cannot totally exclude errors in the manual, for which we apologize.

The data, figures and descriptions contained in this manual cannot be legally asserted. We reserve the right to make changes and corrections without prior notice.

HD2402

Photo-Radiometer / A.O.R. Dosimeter

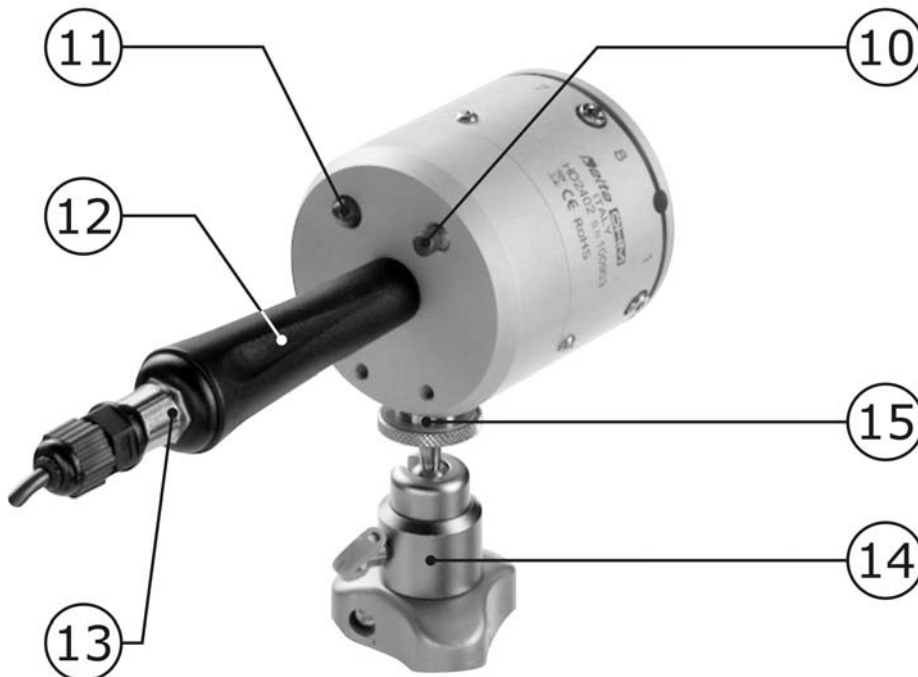
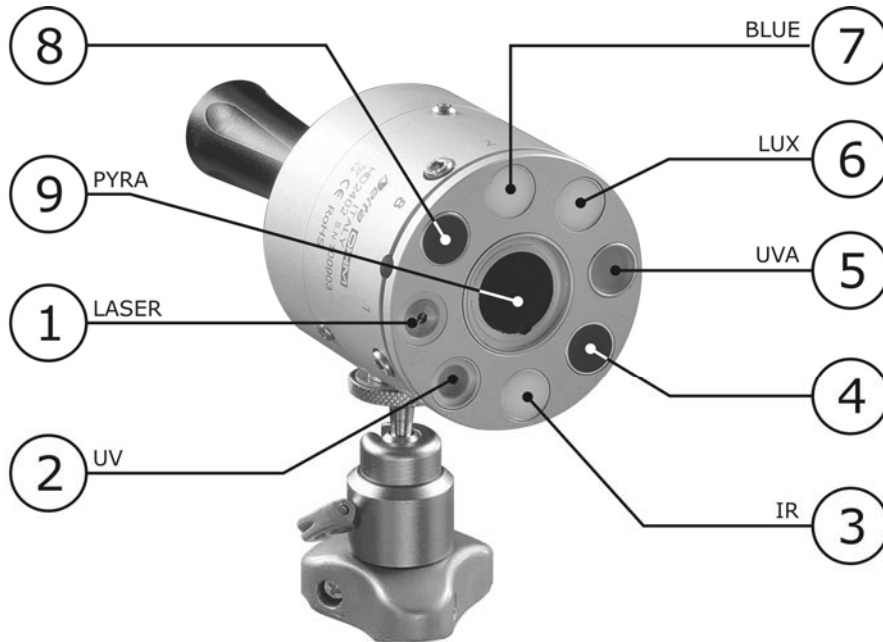

FRONT

1. LASER LED
2. Radiometric sensor for the measurement of UV band (220÷400 nm)
3. Radiometric sensor for the measurement of NIR band (700÷1300 nm)
4. Not used
5. Radiometric sensor for the measurement of UVA band (315÷400 nm)
6. Photometric sensor for the measurement of visible radiation (Luxmeter)
7. Radiometric sensor for the measurement of BLUE band (400÷600 nm)
8. Not used
9. Thermopile sensor for the measurement of NIR-FIR band (400÷2800 nm)

BACK AND SIDE

10. Push-button for the LASER diode pointer activation and for the instrument control when this is not connected to a PC
11. LED indicator: displays the instrument status
12. Handle
13. M12 connector for the instrument connection to a PC or to a power supply unit
14. Tripod
15. Connection for fixing the instrument to the tripod



ATTENTION !

WHEN SWITCHING ON THE LASER, DO NOT EXPOSE EYES OR SKIN TO THE LASER DIRECT RADIATION.

WHEN THE LASER IS SWITCHED ON, MAKE SURE THAT NO ONE CROSSES INADVERTEDLY THE LASER BEAM

TABLE OF CONTENTS

1	INTRODUCTION	5
2	RADIOMETRY OVEROBSERVATION	8
	2.1 Irradiance	8
	2.2 Radiance.....	9
3	OPERATING PRINCIPLE	11
4	INSTRUMENT INSTALLATION	15
	4.1 Connection to a PC	15
5	DESCRIPTION OF OPERATION	16
6	MANAGEMENT OF A MEASUREMENT CAMPAIGN WITH DELTALOG13	18
	6.1 Setting measurement scales	18
	6.2 Logging mode.....	19
	6.3 Downloading measurement stored in the PC	20
	6.4 Data analysis and evaluation report	21
	6.4.1 Geometric parameters.....	25
	6.4.2 Luxmeter table.....	26
	6.4.3 a. 180-400 table	27
	6.4.4 b. 315-400 table	27
	6.4.5 c.d. 300-700 table	28
	6.4.6 g.h.i. 380-1400 table	33
	6.4.7 j.k.l. 780-1400 table	38
	6.4.8 m.n.o. 380-3000 table	43
	6.4.9 Notes table.....	44
	6.4.10 Report table	44
7	SPECTRUM FEATURES	46
	7.1 Spectral interval 180-400nm	46
	7.2 Spectral interval 315-400nm (UVA)	47
	7.3 Spectral interval 300-700nm	47
	7.4 Spectral interval 380-1400nm.....	48
	7.5 Spectral interval 780-1400nm.....	48
	7.6 Spectral interval 380-3000nm.....	49
8	SENSOR CALIBRATION	50
9	TECHNICAL SPECIFICATIONS	51
10	STORAGE	53
11	SAFETY INSTRUCTIONS	53
12	ORDER CODES	54

1 INTRODUCTION

HD2402 is a portable datalogger photo-radiometer for the measurement of **non-coherent optical radiations in accordance with 2006/25/CE European directive and legislative decree No 81 of 9 April 2008**.

The instrument consists of a series of sensors used to cover the different portions of the spectrum and of a small LASER used to point the analyzed source.

The different sensors operate in the following spectral ranges:

- Photometric sensor for the measurement of illuminance (luxmeter) in the spectral range 380÷780 nm.
- Radiometric sensor for UV band (220÷400 nm) with spectral weight factor $S(\lambda)$.
- Radiometric sensor for UVA band (315÷400 nm).
- Radiometric sensor for 400÷700 nm (blue) band with spectral weight factor $B(\lambda)$.
- Radiometric sensor for IR band (700÷1300 nm) with spectral weight factor $R(\lambda)$.
- Thermopile sensor for the measurement of infrared radiance, 400÷2800 nm spectral range.

HD2402 unit can be powered through connection to the USB port of a PC, or through an external power supply unit provided with an USB port (**SWD05** code). The **CP24** connection cable is provided with a M12 connector on the instrument side and with an A-type USB connector on the PC side or on the **SWD05** power supply unit side.

HD2402 can be configured (calendar, date, time, start time and logging time) by means of **DeltaLog13 software, from 1.0.1.0 version**, and a PC; additionally, stored data can be downloaded and analyzed and new data can be acquired in real time. Once configured, the datalogger can be disconnected from the PC and connected to the power supply unit for data acquisition and storage according to the programmed settings.

The unit is provided with a button for data storage manual start/stop when the unit is not connected to a PC.

A LED indicator on the back of the unit shows the instrument's acquisition state.

The legislative decree No 81/08, paragraph 5, establishes the measurement of artificial optical radiations (AOR) produced by incoherent light and coherent light (LASER). **HD2402** unit can perform characterization of incoherent sources and in this manual, unless otherwise specified, reference will be made only to this kind of sources.

Attachment No 37 of L.D. 81/08 provides the formulas (Table 1) to determine the biophysically-relevant limit values of exposure to optical radiations.

(a)	$H_{\text{eff}} = \int_0^t \int_{\lambda = 180 \text{ nm}}^{\lambda = 400 \text{ nm}} E_{\lambda}(\lambda, t) \cdot S(\lambda) \cdot d\lambda \cdot dt$	(H_{eff} is only relevant in the range 180 to 400 nm)
(b)	$H_{\text{UVA}} = \int_0^t \int_{\lambda = 315 \text{ nm}}^{\lambda = 400 \text{ nm}} E_{\lambda}(\lambda, t) \cdot d\lambda \cdot dt$	(H_{UVA} is only relevant in the range 315 to 400 nm)
(c), (d)	$L_B = \int_{\lambda = 300 \text{ nm}}^{\lambda = 700 \text{ nm}} L_{\lambda}(\lambda) \cdot B(\lambda) \cdot d\lambda$	(L_B is only relevant in the range 300 to 700 nm)
(e), (f)	$E_B = \int_{\lambda = 300 \text{ nm}}^{\lambda = 700 \text{ nm}} E_{\lambda}(\lambda) \cdot B(\lambda) \cdot d\lambda$	(E_B is only relevant in the range 300 to 700 nm)
(g) to (l)	$L_R = \int_{\lambda_1}^{\lambda_2} L_{\lambda}(\lambda) \cdot R(\lambda) \cdot d\lambda$	(See Table 1.1 for appropriate values of λ_1 and λ_2)
(m), (n)	$E_{\text{IR}} = \int_{\lambda = 780 \text{ nm}}^{\lambda = 3000 \text{ nm}} E_{\lambda}(\lambda) \cdot d\lambda$	(E_{IR} is only relevant in the range 780 to 3 000 nm)
(o)	$H_{\text{skin}} = \int_0^t \int_{\lambda = 380 \text{ nm}}^{\lambda = 3000 \text{ nm}} E_{\lambda}(\lambda, t) \cdot d\lambda \cdot dt$	(H_{skin} is only relevant in the range 380 to 3 000 nm)

Table 1: formulas for the calculation of limit values

Where :

- $E_{\lambda}(\lambda, t)$, Spectral irradiance or spectral power density: the radiant power incident per unit area upon a surface, expressed in watts per square meter per nanometer [$\text{W}/(\text{m}^2 \text{ nm})$]; $E_i(\lambda, t)$ and E_{λ} values come from measurements or can be supplied by the manufacturer of the equipment;
- H_{eff} Effective irradiance: calculated irradiance within the UV wavelength range 180 to 400 nm, spectrally weighted by $S(\lambda)$, expressed in watts per square meter [W/m^2];
- H Radiant exposure: the time integral of the irradiance, expressed in joule per square meter [J/m^2];
- H_{eff} Effective radiant exposure: spectral weighting by $S(\lambda)$ radiant exposure, expressed in joule per square meter [J/m^2];
- E_{UVA} Total irradiance (UVA): calculated irradiance within the UVA wavelength range 315 to 400 nm, expressed in watts per square meter [W/m^2];
- H_{UVA} Radiant exposure: the time and wavelength integral or sum of the irradiance within the UVA wavelength range 315 to 400 nm, expressed in joule per square meter [J/m^2];
- $S(\lambda)$ Spectral weighting taking into account the wavelength dependence of the health effects of UV radiation on eye and skin [dimensionless];
- $t, \Delta t$ Time, duration of the exposure, expressed in seconds [s];
- λ Wavelength, expressed in nanometers [nm];
- $\Delta\lambda$ Bandwidth, expressed in nanometers [nm], of calculation or measurement intervals;
- $L_{\lambda}(\lambda)$, Spectral radiance of the source, expressed in watts per square meter per steradian per nanometer [$\text{W}/(\text{m}^2 \text{ sr nm})$];

$R(\lambda)$	Spectral weighting taking into account the wavelength dependence of the thermal injury caused to the eye by visible and IRA radiation [dimensionless];
L_R	Effective radiance (thermal injury): calculated radiance spectrally weighted by $R(\lambda)$, expressed in watts per square meter per steradian per nanometer [$W/(m^2 \text{ sr})$];
$B(\lambda)$	Spectral weighting taking into account the wavelength dependence of the photochemical injury caused to the eye by the blue light radiation [dimensionless];
L_B	Effective radiance (blue light): calculated radiance spectrally weighted by $B(\lambda)$, expressed in watts per square meter per steradian [$W/(m^2 \text{ sr})$];
E_B	Effective irradiance (blue light): calculated irradiance spectrally weighted by $B(\lambda)$, expressed in watts per square meter [W/m^2];
E_{IR}	Total irradiance (thermal injury): calculated irradiance within the infrared wavelength range 780 nm to 3 000 nm, expressed in watts per square meter [W/m^2];
E_{skin}	Total irradiance (visible, IRA and IRB): calculated irradiance within the visible and infrared wavelength range 380 nm to 3 000 nm, expressed in watts per square meter [W/m^2];
H_{skin}	Radiant exposure, the time and wavelength integral or sum of the irradiance within the visible and infrared wavelength range 380 nm to 3 000 nm, expressed in joule per square meter [J/m^2];
α	Angular subtense: the angle subtended by an apparent source, as observed at a point in space, expressed in milliradians (mrad). Apparent source in the real or virtual object that forms the smallest possible retinal image.

Limits depend on the wavelengths of the analyzed light and on the kind of injury to be taken into consideration.

Also the physical quantities of interest (irradiance [W/m^2], radiance [$W/(m^2sr)$]) differ depending on the kind of injury to be taken into consideration.

2 RADIOMETRY OVERVIEW

The foregoing exposition is far from being exhaustive, but will be useful to make the HD2402 unit operation known and to understand the approximations made by the instrument for the calculation of the various radiometric quantities requested by L.D. No 81/08.

2.1 IRRADIANCE

Irradiance E_i at a point of a surface is defined as the density of energetic flux $d\Phi_i$ that flows through the unit area dA (Figure 1):

$$E_i = \frac{d\Phi_i}{dA}$$

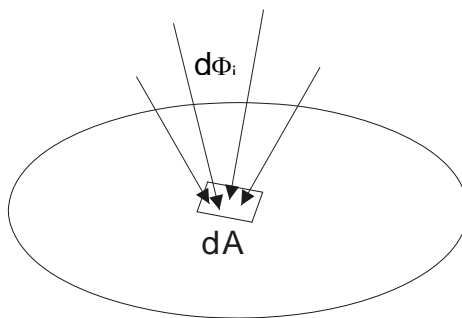

Figure 1: irradiance

The irradiance measurement unit is $[W/m^2]$; when calculated at different wavelengths, we have spectral irradiance $[W/(m^2 \text{ nm})]$.

From the definition of irradiance we obtain some properties useful for understanding the light behavior:

1. We have maximum irradiance on a surface when the incident light beam is perpendicular to the surface and decreases with the incident angle according to the cosine formula (Law of Cosine):

$$E_i = E_{i_0} \cdot \cos(\theta)$$

where:

E_i is the irradiance on the surface taken into consideration,

E_{i_0} is the irradiance when the surface is perpendicular to the flux,

θ is the angle between the surface and the flux direction.

2. As to a point light source (or to be considered as such) that radiates light uniformly in all directions (isotrope), the irradiance produced on a surface decreases with the square of the distance.

2.2 RADIANCE

Radiance L_i at a point of a surface is defined as the energetic flux $d^2\Phi_I$ that flows through a surface dA per unit solid angle $d\Omega$ (Figure 2):

$$L_i = \frac{d^2\Phi}{dA \cdot d\Omega}$$

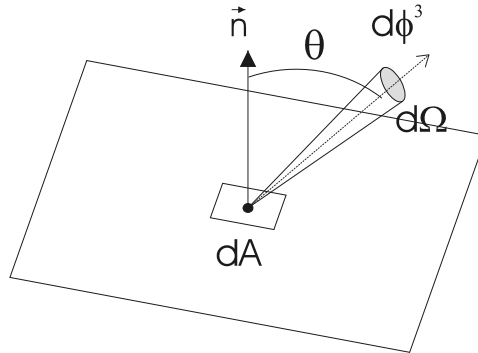

Figure 2: radiance

The radiance measurement unit is $[W/(m^2 \text{ sr})]$; when calculated at different wavelengths, we obtain the spectral radiance $[W/(m^2 \text{ nm sr})]$.

A solid angle is the angle subtended at a point P by a closed surface A . It is calculated as the relation between the surface projected on a sphere of radius R with center in P and R^2 . The measurement unit of a solid angle is the steradian $[\text{sr}]$ and its value ranges between 0 and 4π .

Radiance and irradiance are two different quantities. Radiance describes the angular distribution of radiation while irradiance integrates radiance in all directions. The primary relation linking irradiance to radiance is:

$$E_i = \int_{\Omega} L_i(\theta, \phi) \cdot \cos(\theta) d\omega$$

If radiance is uniform, then the term $L(\theta, \phi)$ can be taken out from the integral and the expression is simplified as follows:

$$E_i = L_i \int_{\Omega} \cos(\theta) d\omega = L_i \cdot F$$

Where F depends only on geometry.

In these particular conditions, the radiance value can be obtained from that of the irradiance: hence, the formula will be:

$$L_i = \frac{E_i}{F}$$

Remark: for small angles, F is actually the solid angle under which the observer source is seen.

By using this reduction, HD2402 unit allows to calculate the radiance of the irradiance measured values.

Similar definitions apply to photometry where irradiance will be replaced by illuminance (lux) and radiance by luminance [cd/m^2].

More generally, the link between any spectral radiometric quantity $GR(\lambda)$ and the corresponding photometric quantity GF is given by the following formula:

$$GF = 683 \cdot \int_{380}^{780} GR(\lambda) \cdot V(\lambda) d\lambda$$

where :

$V(\lambda)$ is the photopic vision curve (Figure 3), 380nm and 780nm are the integration extremes, out of these extremes $V(\lambda)=0$.

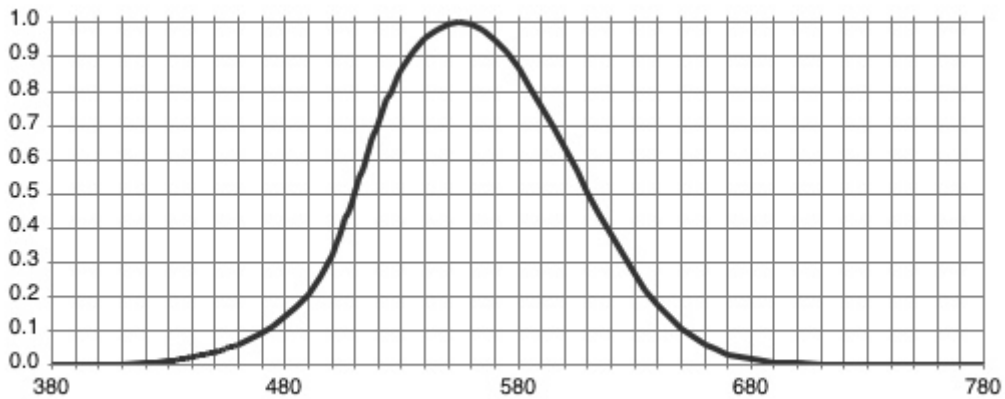

Figure 3: luminous efficacy curve for the photopic vision

The photopic vision curve represents the luminous efficacy of the human eye under daylight conditions (in lowlight conditions, the response curve of the human eye changes, and we talk about a scotopic vision).

3 OPERATING PRINCIPLE

6 sensors are used for the measurement of optic radiations. Each sensor covers a given spectral range and measurements in conformity with L.D. 81/08 can be performed through the combination of signals coming from several sensors. The sensors used are photodiodes, except for channel 9 that utilizes a thermopile sensor.

The instrument is provided with a pointing LASER to indicate to the user the area outlined by the instrument. The LASER is switched on by means of the button on the rear of the instrument. By pressing the button, the LASER is switched on for 10 seconds.

HD2402 is powered through the USB cable, when it is connected to a PC. The red indicator on the back of the instrument shows that the instrument is properly powered.

Table 2 lists all channels available in the instrument with their spectral range and corresponding spectral weighting curve ($V[\lambda]$, $S[\lambda]$, $B[\lambda]$, $R[\lambda]$), implemented through the use of appropriate filters.

Channel	Measure quantity	Spectral range and corresponding weighting curve	Sensor type
6	Illuminance [Lux]	380nm÷780nm; $V[\lambda]$	Photodiode + Filter
2	Irradiance [W/m^2]	220nm÷400nm; $S[\lambda]$	Photodiode + Filter
5	Irradiance [W/m^2]	315nm÷400nm; UVA	Photodiode + Filter
7	Irradiance [W/m^2]	400nm÷600nm; $B[\lambda]$	Photodiode + Filter
3	Irradiance [W/m^2]	660nm÷1300nm; $R[\lambda]$	Photodiode + Filter
9	Irradiance [W/m^2]	400nm÷3000nm	Thermopile

Table 2: measurement channels available in the instrument

Processing of the sensor output signal is handled independently for each channel and in different modes.

Transimpedance amplifiers are used for channels 3, 5 and 6. Signal is acquired 1000 times per second. Both the average value per second and the peak signal of the 1000 samples acquired is displayed by the software. The amplifiers have 4 scales each, that are independent of the other. Scale change is automatic or manual.

Channels 2 and 7 use a charge integrator. The integration time depends on the required sensitivity, ranging from 1 ms in the low sensitivity scale to 1 second in the full sensitivity scale (there are 4 scales, that are independent for the two channels). Also in this case, the instrument displays the mean value per second and the peak signal of the acquired samples (in the full sensitivity scale, when the integration time is 1 second, mean value and peak value coincide). The scale change is automatic or manual.

Channel 9 is a power amplifier. There is only 1 scale. In this case, only the mean value is displayed, since the response time of the sensor is of about 9 seconds.

Table 3 shows the full scale values available for each channel:

Channel	Meas. unit	Full scale 1	Full scale 2	Full scale 3	Full scale 4
6	Lux	399.9	$3.999 \cdot 10^3$	$39.99 \cdot 10^3$	$399.9 \cdot 10^3$
2	W/m^2	$39.99 \cdot 10^{-3}$	$399.9 \cdot 10^{-3}$	3.999	39.99
5	W/m^2	3.999	39.99	399.9	$3.999 \cdot 10^3$
7	W/m^2	$399.9 \cdot 10^{-3}$	3.999	39.99	399.9
3	W/m^2	3.999	39.99	399.9	$3.999 \cdot 10^3$
9	W/m^2	$3.999 \cdot 10^3$			

Table 3: scales available for each of the instrument's channels

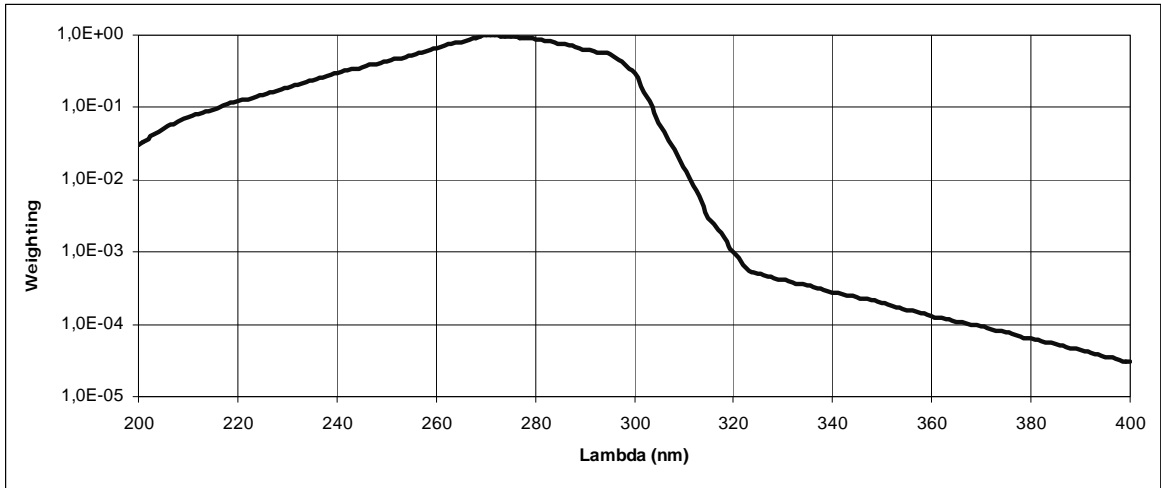

Figure 4: Spectral weighting curve $S(\lambda)$ (wavelengths below 200nm are not taken into consideration, as highly absorbed in air)

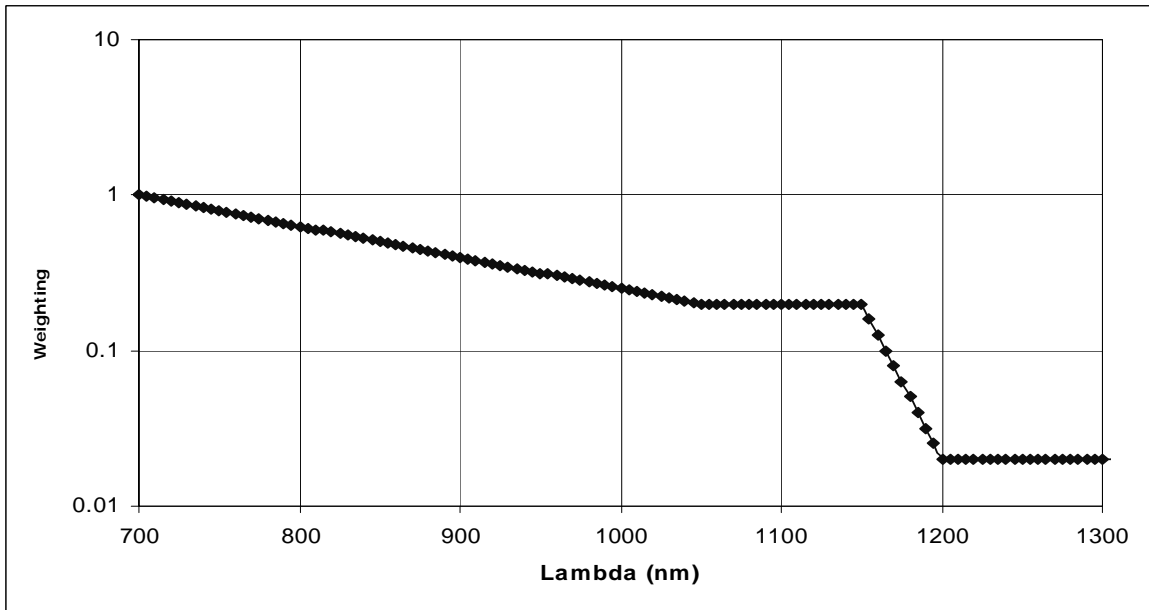

Figure 5: Spectral weighting curve $R(\lambda)$

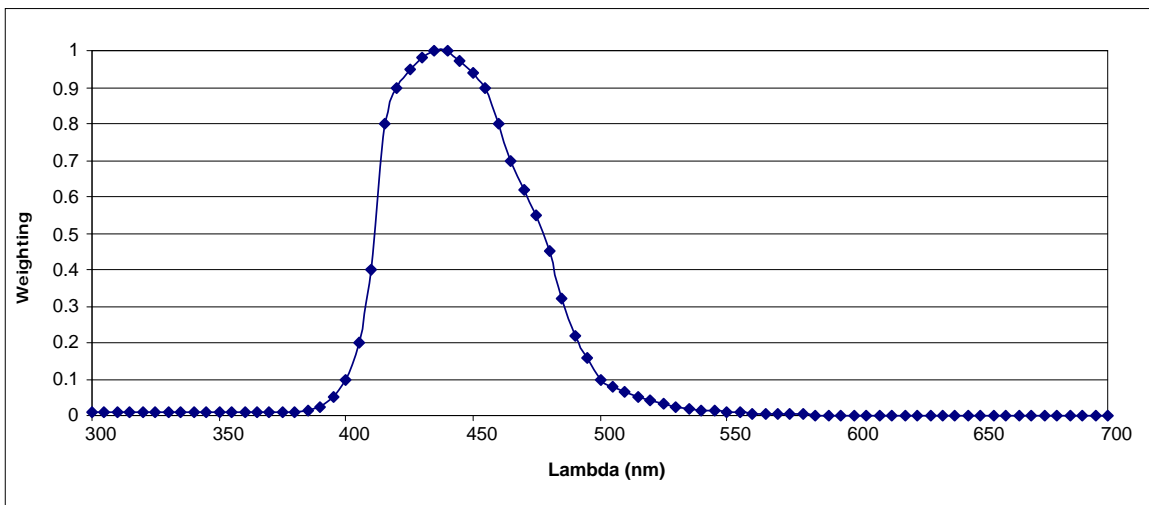

Figure 6: Spectral weighting curve $B(\lambda)$

Table 4 shows the 15 limit values to be calculated according to attachment 37 of L.D. 81/08.

Index	Wavelength nm	Exposure limit value	Units	Comment	Part of the body	Hazard
a.	180-400 (UVA, UVB and UVC)	$H_{eff} = 30$ Daily value 8 hours	[J m ⁻²]		eye cornea conjunctiva lens skin	photokeratitis conjunctivitis cataractogenesis erythema elastosis skin cancer
b.	315-400 (UVA)	$H_{UVA} = 10^4$ Daily value 8 hours	[J m ⁻²]		eye lens	cataractogenesis
c.	300-700 (Blue light) see note 1	$L_B = \frac{10^6}{t}$ for $t \leq 10\ 000$ s	L_B : [W m ⁻² sr ⁻¹] t: [seconds]	for $\alpha \geq 11$ mrad	eye retina	photoretinitis
d.	300-700 (Blue light) see note 1	$L_B = 100$ for $t > 10\ 000$ s	[W m ⁻² sr ⁻¹]			
e.	300-700 (Blue light) see note 1	$E_B = \frac{100}{t}$ for $t \leq 10\ 000$ s	E_B : [W m ⁻²] t: [seconds]	for $\alpha < 11$ mrad see note 2		
f.	300-700 (Blue light) see note 1	$E_B = 0,01$ for $t > 10\ 000$ s	[W m ⁻²]			
g.	380-1 400 (Visible and IRA)	$L_R = \frac{2,8 \cdot 10^7}{C_a}$ for $t > 10$ s	[W m ⁻² sr ⁻¹]	$C_a = 1,7$ for $\alpha \leq 1,7$ mrad $C_a = \alpha$ for $1,7 \leq \alpha \leq 100$ mrad $C_a = 100$ for $\alpha > 100$ mrad $\lambda_1 = 380; \lambda_2 = 1\ 400$	eye retina	retinal burn
h.	380-1 400 (Visible and IRA)	$L_R = \frac{5 \cdot 10^7}{C_a t^{0,25}}$ for $10 \mu s \leq t \leq 10$ s	L_R : [W m ⁻² sr ⁻¹] t: [seconds]			
i.	380-1 400 (Visible and IRA)	$L_R = \frac{8,89 \cdot 10^8}{C_a}$ for $t < 10 \mu s$	[W m ⁻² sr ⁻¹]			
j.	780-1 400 (IRA)	$L_R = \frac{6 \cdot 10^6}{C_a}$ for $t > 10$ s	[W m ⁻² sr ⁻¹]	$C_a = 11$ for $\alpha \leq 11$ mrad $C_a = \alpha$ for $11 \leq \alpha \leq 100$ mrad $C_a = 100$ for $\alpha > 100$ mrad (measurement field-of-view: 11 mrad) $\lambda_1 = 780; \lambda_2 = 1\ 400$	eye retina	retinal burn
k.	780-1 400 (IRA)	$L_R = \frac{5 \cdot 10^7}{C_a t^{0,25}}$ for $10 \mu s \leq t \leq 10$ s	L_R : [W m ⁻² sr ⁻¹] t: [seconds]			
l.	780-1 400 (IRA)	$L_R = \frac{8,89 \cdot 10^8}{C_a}$ for $t < 10 \mu s$	[W m ⁻² sr ⁻¹]			
m.	780-3 000 (IRA and IRB)	$E_{IR} = 18\ 000 t^{0,75}$ for $t \leq 1\ 000$ s	E: [W m ⁻²] t: [seconds]		eye cornea lens	corneal burn cataractogenesis
n.	780-3 000 (IRA and IRB)	$E_{IR} = 100$ for $t > 1\ 000$ s	[W m ⁻²]			
o.	380-3 000 (Visible, IRA and IRB)	$H_{kin} = 20\ 000 t^{0,25}$ for $t < 10$ s	H: [J m ⁻²] t: [seconds]		skin	burn

Table 4: exposure limit values for non-coherent radiations

Different limits correspond to different spectral intervals. Some spectral bands coincide with the spectral response of the utilized sensors, while other sensors need to properly combine several channels. The table shows how HD2402 channels are combined to obtain 13 of the requested 15 limits. Limits **e**, **f** are beyond the measurements achievable with the instrument and, on the other hand, are applied to particular sources (typically, ophthalmology instruments).

Limit	Nominal spectral range	Effective spectral range	Channels
a	180nm÷400nm	220nm÷400nm	<i>f</i> (ch2, ch5)
b	315nm÷400nm	315nm÷400nm	ch5
c, d	300nm÷700nm	315nm÷700nm	<i>f</i> (ch5, ch6, ch7)
g, h, i	380nm÷1400nm	380nm÷1400nm	<i>f</i> (ch3, ch6, ch7)
j, k, l	780nm÷1400nm	700nm÷1400nm	ch3
m, n	780nm÷3000nm	400nm÷3000nm	ch9
o	400nm÷3000nm	400nm÷3000nm	ch9

Table 5: calculation of a-o limits from channels available in the instrument

The quantity measured by HD2402 instrument is always irradiance (or illuminance for what concerns channel 0), while limits **c** to **l** are calculated from the radiance value. As illustrated in chapter 2 (Radiometry overview), the two quantities are related and radiance can be obtained from irradiance (assuming that radiance is constant), provided that the geometric parameters of the measured source are known.

The details of the calculation will be shown in the software description. Even in case the geometric parameters of the source are not known, it is anyway possible to estimate the requested quantities.

4 INSTALLATION OF THE INSTRUMENT

The instrument is provided with a single cable (cod. **CP24**), ending with a M12 connector at the instrument side and an A-type USB connector at the other end. The cable is used both for connection to the external **SWD05** power supply unit and for connection to a PC; in this case, it is directly powered by the USB port of the PC.

The instrument takes about 15 seconds to be operative after connection to a PC or to the power supply unit. During this period, The LED on the back of the instrument blinks once per second. When the Led starts blinking once every three seconds, the instrument is operating.

The instrument is provided with an internal rechargeable battery allowing operation of the internal clock even in the absence of an external power supply. The battery is recharged when the instrument is powered. In the absence of an external power supply, the battery autonomy is of about two months. If the instrument is not connected to a power supply unit or to a PC for more than two months, date and time are cleared and will have to be set again by means of DeltaLog13 software.

During measurements, the instrument must be fixed to the tripod **VTRAP20** by means of the fitting on the instrument side, so as to obtain a better precision and stability in pointing towards the optical radiation source.

In order to perform the measurements, remove the rubber cap protecting the sensors.

To direct the instrument with better accuracy towards the radiation source, turn on the LASER by pressing the button on the rear.

4.1 CONNECTION TO A PC

Instruments are provided with **DeltaLog13 software**. PC-connection operations, setting of operation parameters, measurement setting, data transfer, graphic display, print of acquired or stored measurements can be managed thanks to the software.

The instrument is connected to a USB port of a PC through the **CP24** cable.

Connection through USB port requires previous installation of the instrument drivers included in the CD-ROM supplied with the instrument. **Before connecting the USB cable to the PC, install the drivers** following the instructions of the guide included in the document section of the DeltaLog13 CD-ROM.

5 DESCRIPTION OF OPERATION

The instrument has two operation modes:

- *Instrument connected to the USB port of the PC and managed through the DeltaLog13 software*

The instrument is powered through the USB port of the PC.

A short blink every 3 seconds of the rear LED indicates that the instrument is properly powered.

In order to use the DeltaLog13 software, the supplied CH20-ROA software key must be introduced in a second USB port of the PC.

The instrument connected to the PC is automatically recognized by the software.

After the software startup, the PC monitor shows all measurements in real time.



The displayed values concern the spectral intervals requested in Attachment 37, paragraph 5 of chapter 8 of L.D. 81/08. Besides, all the commands needed to start the measurement campaign are available in the window (see chapter 6 at page 18).

The following functions are available in the command bar, located at the top of the program window (you will find more details on the use of these commands in the *online help* of DeltaLog13 software):

Project icon: by selecting the icon a new project can be created (option *New Project*) or an existing one can be opened (option *Open Project*).

Open...icon: allows to open data files or reports regarding measurements that have already been performed or saved in the folders *Logging* and *Reports* in the predefined folder (preset in *C:\DL13_HD2402* but user changeable).

Start PC Log icon: starts manually logging measurements that will be directly saved in the PC. After starting logging, the icon changes in *Stop PC Log*, allowing to stop logging when desired.

Start Logging icon: starts manually logging measurements that will be saved in the internal memory of the instrument. After starting logging, the icon changes in *Stop Logging*, allowing to stop logging when desired.

Dump LOG icon: allows to download in the PC measurements saved in the internal memory of the instrument.

Instrument setup icon: allows to perform the following settings:

- Start time and duration of a programmed logging;
- Full scale of the measurement range for each channel of the instrument;
- Internal clock;
- Identification code of the instrument.

Calculator icon: allows to calculate the risk index by manually entering the irradiance data.

- *Instrument not connected to a PC and powered through an external power supply unit.*

In this mode, the instrument can be programmed through the DeltaLog13 software and can perform an acquisition with programmed startup and preset time interval, or can be controlled by means of the rear button.

The LED blinks every 3 seconds until acquisition is started and will blink once per second since acquisition startup.

To start and stop logging by means of the rear button, proceed as follows:

Logging startup

- 1 keep the button depressed for at least three seconds;
- 2 the LED indicator will start blinking twice per second;
- 3 keep the button depressed for other two seconds;
- 4 if the measurement is in process, the LED blinks shortly every second.

Logging stop

- 1 keep the button depressed for at least three seconds;
- 2 the LED indicator will start blinking twice per second;
- 3 keep the button depressed for other two seconds;
- 4 if the measurement was stopped, the LED blinks shortly every 3 seconds.

Memory capacity

The instrument saves data every second. Up to 96000 samples can be stored, that are equivalent to 26 hours of continuous acquisition. Memory is cyclic, so data are overwritten starting from the older sample, once the available space is depleted.

6 MANAGEMENT OF A MEASUREMENT CAMPAIGN WITH DELTALOG13

The chapter describes all steps needed to perform a measurement campaign, with the purpose to evaluate and analyze one or more sources and positions in the same place.

A measurement campaign is performed through the following steps:

1. Setting measurement scales for the different channels;
2. Setting mode and duration of the measurement log;
3. Measurement log;
4. Download to a PC of the acquired measures, if these were stored in the internal memory of the instrument.
5. Analysis of data and issue of evaluation report.

6.1 SETTING MEASUREMENT SCALES

Before every reading it is of the utmost importance to check that the proper measurement ranges are set in the instrument. If the set measurement range is too small, measurements can be beyond full scale, thus not allowing a proper evaluation of the readings.

4 measurement scales are available for all the channels, except for channel 9, that has only one measurement scale (Table 3 at page 11).

In order to set measurement ranges, connect the instrument to a PC, start Delta-Log13 and wait for the automatic identification of the instrument. Select the *Instrument Setup* icon and then the *Input setting* item. The following window will appear:

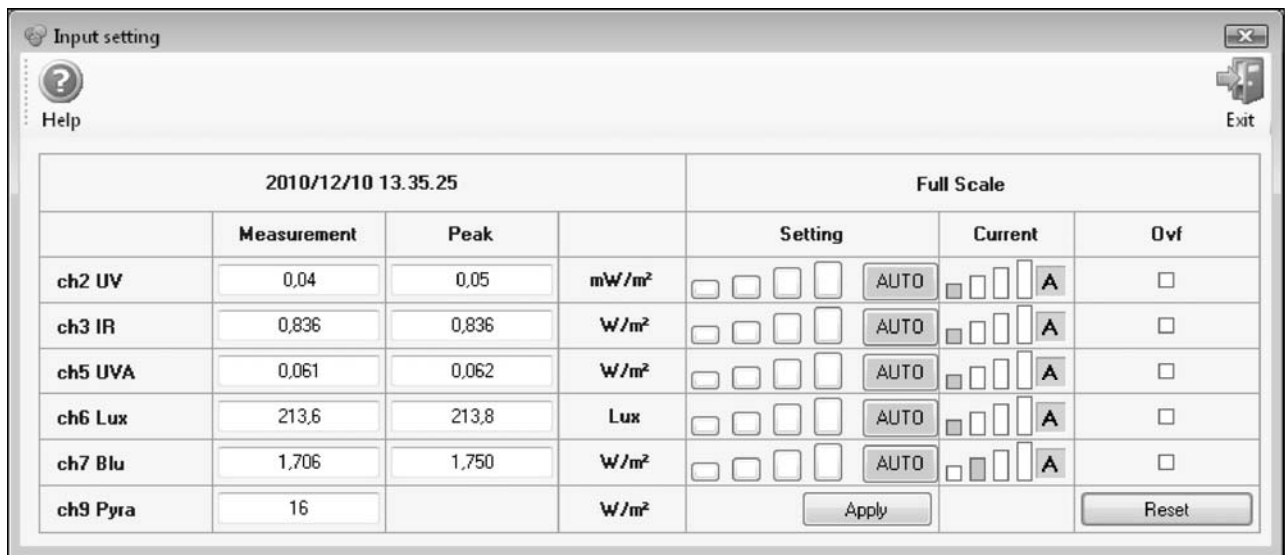

The following values are displayed for each measurement channel, except for channel 9: measured value (mean value per second), peak value (per second), preset measurement scale and current scale, that is the scale in use at the moment of the last acquisition.

The preset scale is in light blue color. All scales are factory preset to *AUTO* (automatic). Scales for each channel can be set manually, by mouse-clicking on the desired scale (the smallest bar indicates the full sensitivity scale).

In case of doubt, it is advisable to select the *AUTO* setting, leaving to the instrument the most appropriate choice to use.

Once a new scale is set, the *Apply* key must be pressed to activate the change. When pressing the *Apply* key, the setting of inputs is saved in the instrument and will remain active even if the instrument is subsequently disconnected.

If a channel measurement is beyond full scale, the corresponding indicator in the column *Ovf* will appear in red color.

6.2 LOGGING MODE

It is possible to select if to directly log measurements in a PC or in the external memory of the instrument.

PC data logging can only be started manually by selecting the *Start PC Log* icon.



In this case, the instrument will necessarily have to remain connected to the PC during data logging. After logging startup, the *Start PC Log* icon is replaced by the *Stop PC Log* icon. To stop logging, select the *Stop PC Log* icon. Data are saved in the Monitor folder in the predefined folder; the file will be identified by the logging start/stop time.

Data logging in the instrument memory can be started in a programmed way or manually. To set the programmed log, select the *Instrument setup* icon and then the *Logging setting* item. The following window will appear:

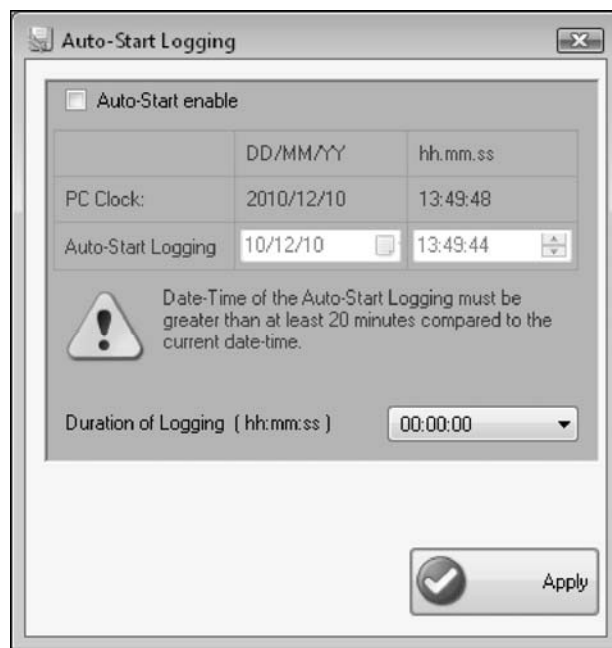

Select the *Auto-Start enable* box, set logging start date/time in the *Auto-Start Logging* line (start time must be subsequent to the current time indicated in the *PC Clock* line by at least 20 minutes), set log duration in the *Duration of Logging* field

(hh:mm:ss). Select the *Apply* key to save the instrument settings, logging will automatically start at the set date/time. The instrument can also be disconnected from the PC and connected to the power supply unit. The rear LED blinks every 3 seconds until acquisition is started; the Led will start blinking once per second from the moment acquisition is started.

Manual logging in the instrument memory is started by selecting the *Start Logging* icon (or in alternative by pressing the rear button for 5 seconds).



After logging startup, the *Start Logging* icon is replaced by the *Stop Logging* icon. To manually stop logging, select the *Stop Logging* icon (or in alternative press the rear button for 5 seconds). Data are saved in the Monitor folder in the predefined folder; the file will be identified by the logging start/stop time

Logging can be manually started and automatically stopped by setting the *Duration of Logging* field (hh:mm:ss) in the Auto-Start Logging window. In this case, the *Auto-start enable* box must not be selected.

Note: before starting logging, make sure that the instrument date/time are correct, by selecting the *Instrument Setup* icon and then the *Clock Setting* item.

6.3 DOWNLOAD OF THE MEASUREMENTS STORED IN THE PC

If data have been logged in the instrument internal memory, they must be downloaded to a PC for analysis.

Connect the instrument to a PC, start DeltaLog13 and wait for automatic detection of the instrument. Select the *Dump LOG* icon.



A list of the files stored in the instrument memory will appear.

The screenshot shows a window titled 'List of Files' with a toolbar containing 'Select all', 'Deselect all', 'Dump LOG', and 'Clear memory instrument' buttons. Below the toolbar is a table with the following data:

	Start Date/Time	End Date/Time	Number of Pages	Path of downloaded files
<input checked="" type="checkbox"/>	2010/11/30 09.40.26	2010/11/30 09.40.39	0002	
<input type="checkbox"/>	2010/11/30 09.45.47	2010/11/30 09.46.47	0006	
<input type="checkbox"/>	2010/11/30 09.47.32	2010/11/30 09.49.01	0008	

The start/stop time for each log is displayed. Select logs to be downloaded and press the *Dump LOG* icon. Data are saved in the *Logging* folder, in the predefined folder; files will be identified by the logging start/stop time.

Please refer to the software manual or online help for details on the functions available in the window containing the log list.

6.4 DATA ANALYSIS AND EVALUATION REPORT

Select the *Project* icon and then the *New project* item for the analysis of the data detected by the instrument.

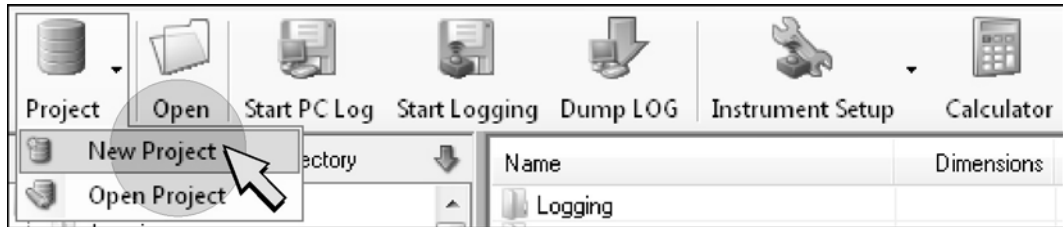

The program asks for a name to assign to the project file and the path where to save it; enter the requested info and press *Save*, the project window will open.

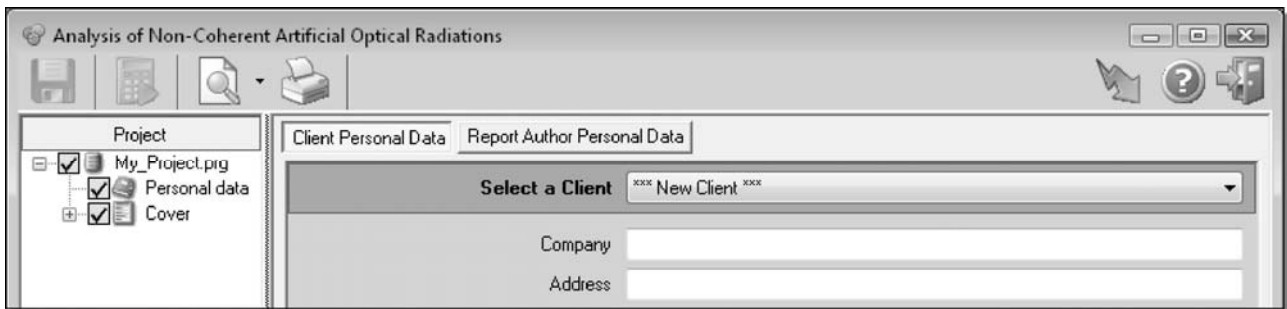

The data concerning the customer and the author of data evaluation can be entered in the right panel of the window. As to the management of anagraphic data, see the software manual.

In the left panel of the window, select the name of the project, press the right key of your mouse and select *New Source*.



The program asks to enter a description of the source and the place where it is positioned, enter the requested info and press *OK*, the entered data appear in the right panel. In the left panel, the source appears among the project items.



The right panel contains two additional columns: *N. Measures Done* (number of measures performed on the source) and *N. Measures Report* (number of measures used to prepare the evaluation report). The column content is void for the moment and will be updated afterward, when some measurements will be associated to the source.

Proceed the same way to add other sources to the project.

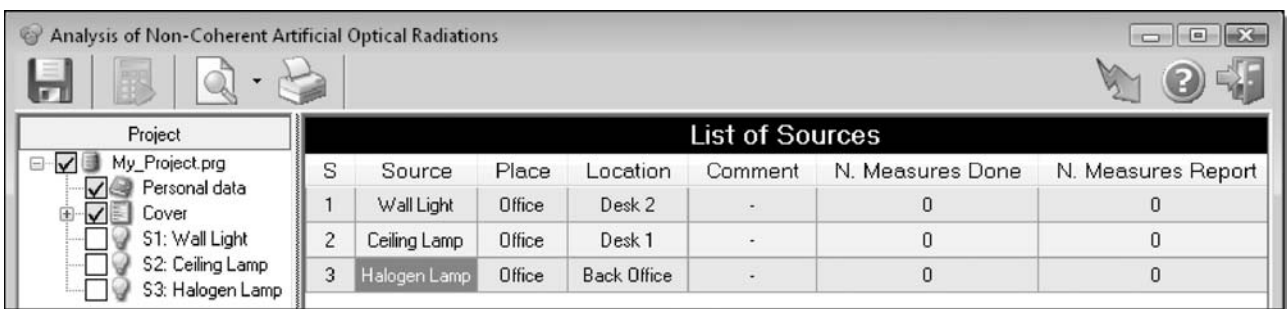

At this point, the detected measures can be associated to each source. Select a source and press the right key of your mouse, then select *New Measurement* and after that one of the following options:

- *From File*: to analyze data already logged and saved in a PC;
- *From Instrument*: to acquire and analyze a new series of measurements in real time.

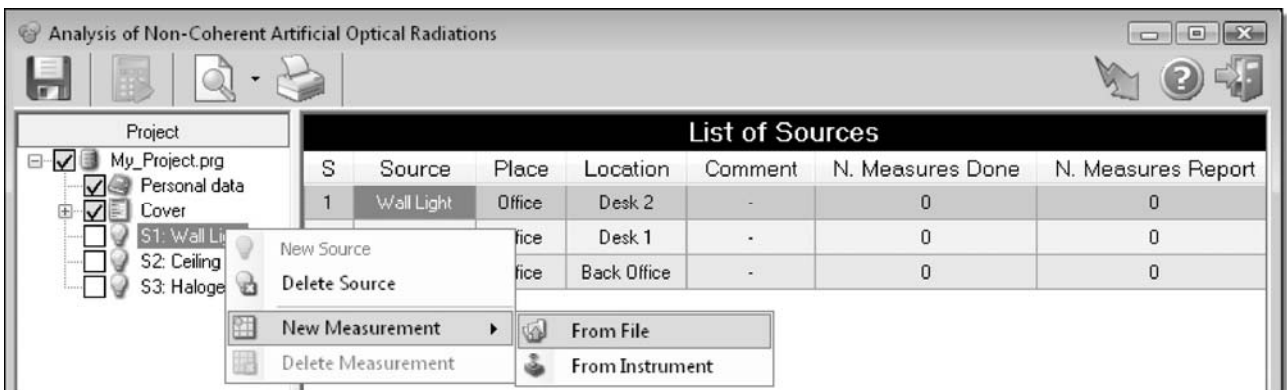

If the *From File* option has been selected, a window will appear where to search for the log file; select the desired file and press *Open*.

After choosing the data origin, by selecting a measurement file associated to a source, the following window will appear.

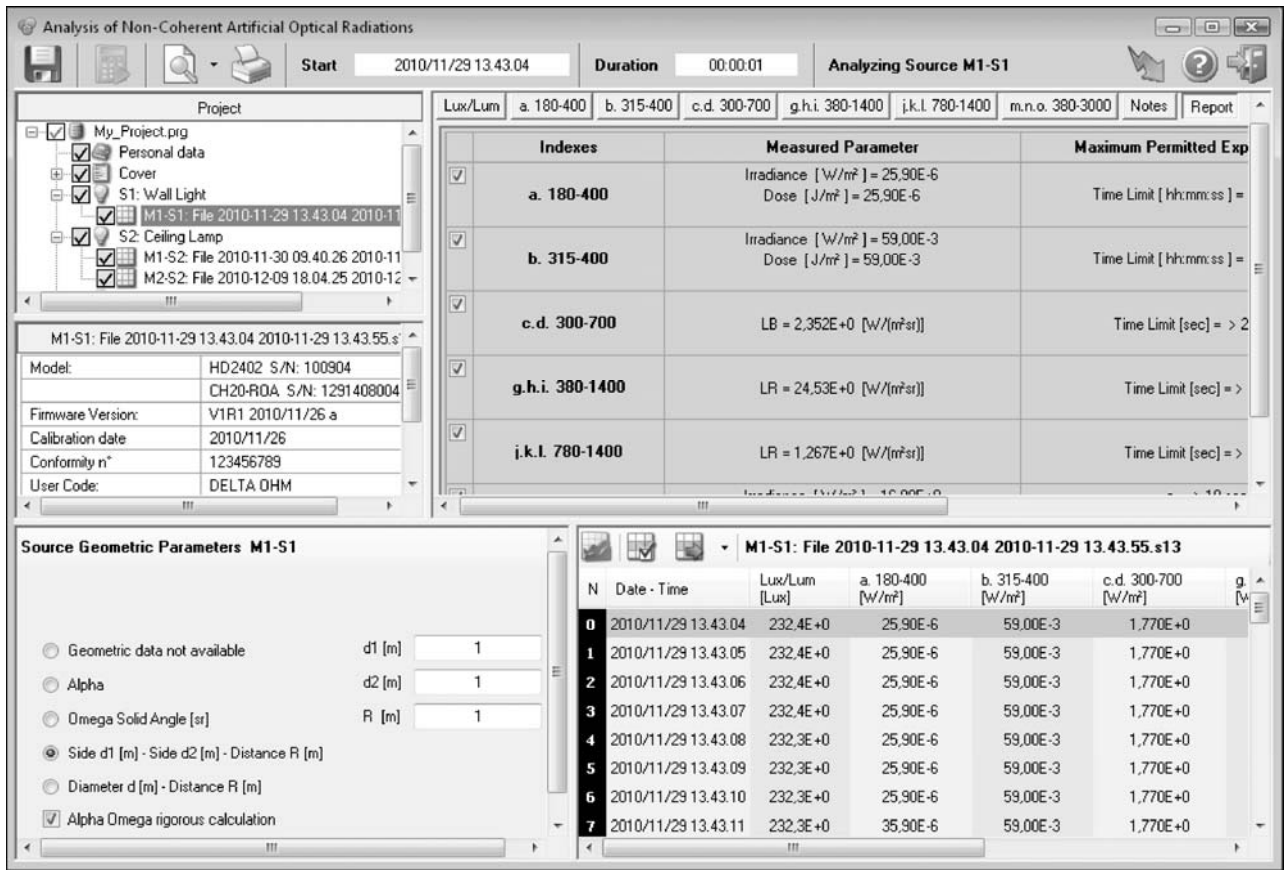

The window is divided into five panels:

- The panel with the project components (in the upper left side), where the log file is now present.
- The panel with the selected file information (placed below the panel of the project components).
- The panel where the geometric parameters of the analyzed source must be entered (in the lower left side).
- Right lower panel, containing the list of the logged measurements if the option *From File* was selected, or the fields where the measurements detected by the instrument are displayed, if the option *From Instrument* was selected.
- Right upper panel, containing the risk indexes evaluation results.

If the option *From Instrument* was selected as the data origin, select the *Start* icon (green arrow) to start logging, the right lower panel will display measurements in real time. To stop acquisition, select the *Stop* icon (red square), the right lower panel of the project window will show the list of the acquired measurements. Measurements are saved in a file in the *Monitor* folder; the file will appear among the items of the project in the left upper panel.

The results of the evaluation that are displayed in the right upper panel refer only to the measurements selected in the list and not to all the listed measurements.

It is possible to keep memory of the selection saving it in the project, by pressing the *Save* icon. After the saving, the selection will appear with a gold background. Only the

measurements with a gold background will be considered in the final evaluation report.

The evaluation can be performed using several consecutive measurements, selecting them by means of the SHIFT key on the PC keyboard (select the first measurement of the series, then keep the SHIFT key depressed and select the last measurement of the series), and pressing the *Save* icon.

If you wish to perform the evaluation keeping into consideration all the measurements in the file, select the *Select All* icon and then the *Save* icon to save the selection in the project.

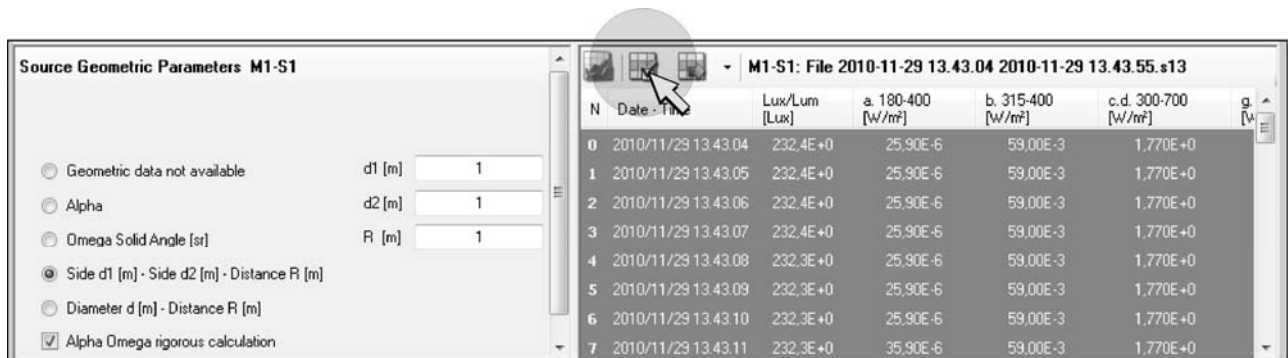

The same file can be associated to a source more than once, so as to be able to perform the analysis with different geometric parameters or with a different selection of measurements.

Selecting the *Display Report* icon, the evaluation report can be displayed and subsequently printed or exported in different formats. The various sources and logs can be included or excluded from the report by simply selecting or deselecting the corresponding boxes in the left upper panel, that displays the items of the project.

To save the project, select the *Save* icon on top of the project window. The geometric parameters, all measurement data and the measurement selection for each data file associated to the project are also saved in the project file.

To remove sources or records from the project, select them in the left upper panel and press the right key of your mouse, then select *Delete Source* or *Delete Measurement*.

Details concerning the setting of geometrical parameters and calculation of exposure limit values requested by the L.D. 81/08 and specified in the tables in the right upper panel are explained below.

6.4.1 Geometrical parameters

The instrument measures irradiance, while radiance value must be known for calculating some exposure limit values (ELV). If geometric parameters are known, both quantities can be calculated (the solid angle subtended from source to sensor must be known) through calculation of the geometric parameter F.

The expected geometries are 5:

- *Geometric data not available*: the event is contemplated, where no indication can be provided on the source geometry. In this case, data supplied by the software will be less complete, details are specified in the following paragraphs illustrating ELV calculation.
- *Alpha [deg]*: the user supplies the source angular dimension in degrees.
- *Omega Solid Angle [sr]*: the user supplies the solid angle under which the source is seen by the measurement device (the measurement unit is the steradian).
- *Side d1 [m] - Side d2 [m] – Distance R [m]*: assuming that the source has a rectangular shape whose side lengths are d1 and d2 at R distance from the measuring device (where the three quantities are expressed in meters), the software provides for the calculation of the angle (alpha) and of the solid angle (omega) subtended from the source to the measuring device. Calculation can be correctly performed by selecting the *Alpha Omega rigorous calculation* box or in an approximate way. In this mode, the angles subtended by the two sides of the rectangle are calculated with the formula:

$$\alpha_1 = \frac{d_1}{R} [rad] \quad \alpha_2 = \frac{d_2}{R} [rad]$$

- *Diameter d [m] – Distance R [m]*: assuming that the source has a circular shape with diameter d and is at R distance from the measuring device (both measurements are expressed in meters) the software provides for the calculation of the angle (alpha) and of the solid angle (omega) subtended from the source to the measuring device. Calculation can be correctly performed by selecting the *Alpha Omega rigorous calculation* calculated with the formula or in an approximate way. In this mode, the angle subtended from the source with respect to the measuring device is calculated with the formula:

$$\alpha = \frac{d}{R} [rad]$$

Once the solid angle is known, the radiance L_i [W/(m²sr)] is given by the formula:

$$L_i = \frac{E_i}{F}$$

Where:

E_i is the irradiance measured in W/m²;

F is the geometric parameter in steradians, as described at paragraph 2.2 at page 9.

If the *non rigorous calculation* option (suitable for small angles) was selected, $F=\Omega$ in all the mentioned cases.

6.4.2 Luxmeter table

The values measured by the luxmeter are displayed in the **Luxmeter** table.

Lux/Lum			
a. 180-400	b. 315-400	c.d. 300-700	g,h,i. 380-1400
j,k,l. 780-1400	m,n,o. 380-3000	Notes	Report
Luxmeter			
Input data		Luminance L	
Illuminance [Lux]	1,000E+0	[cd/m²]	
Alpha [deg]	53,13E+0	L	1,329E+0
Alpha [rad]	927,3E-3	L @ 100 mrad	-
Omega [sr]	805,4E-3	L @ 11 mrad	-
<input checked="" type="checkbox"/> Include in Report			

The data displayed in the table are:

- Illuminance value in Lux (if a single sample is considered, the value corresponds to the instant value or, if several samples are taken into consideration, it corresponds to the mean value).
- Alpha angle in degrees, it is the angle under which the analyzed source is seen.
- Alpha angle in radians, equal to the above mentioned angle, but expressed in radians.
- Omega solid angle in steradians, a solid angle under which the analyzed source is seen. This angle is used for the calculation of luminance.
- Luminance calculated starting from geometric parameters, if available. The luminance value for the analyzed source is obtained by dividing illuminance by factor F calculated from geometric data. In case of measurements regarding ordinary illumination light (white light), if the calculated value is below 10000 cd/m², additional verifications are not necessary and the source is considered safe ("A Non-Binding Guide to the Artificial Optical Radiation Directive 2006/25/EC" page 74).
- Luminance calculated considering a 100mrad angular aperture.
- Luminance calculated considering a 11mrad angular aperture.

Note: the two last luminance values are supplied in case geometric parameters are not available or in case Alpha angle obtained from geometric parameters is below 100mrad.

If the *Include in Report* box is selected, the data in the table will be included in the final report.

6.4.3 Table a. 180-400

Table a. 180-400 describes the exposure limit for parameter "a".

Lux/Lum	a. 180-400	b. 315-400	c.d. 300-700	g.h.i. 380-1400	j.k.l. 780-1400	m.n.o. 380-3000	Notes	Report
Risk index: a								
Input data				Result				
Irradiance [W/m ²]	1,000E+0			Time Limit [hh:mm:ss]				
Dose [J/m ²]	1,000E+0			00:00:30				
<input checked="" type="checkbox"/> Include in Report								

The displayed data are:

- Effective irradiance value E_{eff} [W/m²] (corresponds to the instant value if a single sample is considered, or to the mean value if several samples are considered).
- Effective dose value H_{eff} [J/m²] regarding the considered samples.
- Time in hours/minutes/seconds for exceeding 30 J_{eff}/m² maximum daily dose calculated starting from the irradiance mean value.

If the *Include in Report* box is selected, the data in the table will be included in the final report.

6.4.4 Table b. 315-400

Table b. 315-400 shows the exposure limit for parameter "b".

Lux/Lum	a. 180-400	b. 315-400	c.d. 300-700	g.h.i. 380-1400	j.k.l. 780-1400	m.n.o. 380-3000	Notes	Report
Risk index : b								
Input data				Result				
Irradiance [W/m ²]	1,000E+0			Time Limit [hh:mm:ss]				
Dose [J/m ²]	1,000E+0			02:46:40				
<input checked="" type="checkbox"/> Include in Report								

The displayed data are:

- Irradiance value E_{UVA} [W/m²] (corresponds to the instant value if a single sample is considered, or to the mean value if several samples are considered).
- Dose value H_{UVA} [J/m²] regarding the considered samples.
- Time in hours/minutes/seconds for exceeding 10000 J_{UVA}/m² maximum daily dose calculated starting from the irradiance mean value.

If the *Include in Report* box is selected, the data in the table will be included in the final report.

6.4.5 Table c.d. 300-700

Table c.d. 300-700 shows L_B exposure limit for parameters "c" and "d".

Lux/Lum				
a. 180-400	b. 315-400	c.d. 300-700	g.h.i. 380-1400	j.k.l. 780-1400
m.n.o. 380-3000				
Notes				
Report				
Risk indexes: c d				
Input data		Radiance L_B	$[W/(m^2sr)]$	Time Limit [sec]
Irradiance $[W/m^2]$	1,000E+0	LB	1,329E+0	> 24 hours
Alpha [deg]	53,13E+0	LB @ 100 mrad	1,329E+0	-
Alpha [rad]	927,3E-3	LB @ 11 mrad	1,329E+0	-
Omega [sr]	805,4E-3	LB @ 1.7 mrad	1,329E+0	-
<input checked="" type="checkbox"/> Include in Report				

The limit varies according to the source observation time and angular dimensions; consequently, different exposure limits correspond to different observation times and dimensions. In particular:

$$L_B = 10^6/t [W m^{-2} sr^{-1}] \text{ for } t \leq 10000s \text{ (limit c)}$$

$$L_B = 100 [W m^{-2} sr^{-1}] \text{ for } t > 10000s \text{ (limit d)}$$

The displayed values are:

- Irradiance value $E_B [W/m^2]$ (corresponds to the instant value if a single sample is considered, or to the mean value if several samples are considered).
- Alpha angle in degrees, it is the angle under which the analyzed source is seen.
- Alpha angle in radians, equal to the above mentioned angle, but expressed in radians.
- Omega solid angle in steradians, a solid angle under which the analyzed source is seen. This angle is used for the calculation of luminance.

This parameter is evaluated based on the radiance value and not on that of irradiance, so the more detailed are the entered geometric parameters, the more plentiful will be the data on limit value.

All possible cases are analyzed in the following.

- **Geometric data not available:**

- L_B (100mrad) $[W/(m^2 sr)]$, radiance calculated assuming that all the light comes from a circular area whose angular dimension is 100mrad.

This is true for each source (even with an angular dimension below 100mrad) if the observation time is above 10000s; in fact, for such long time periods any source has a minimum angular dimension of 100mrad (for the human visual system) (CEI IEC 62471).

If value $L_{B_100} \leq 100 [W/(m^2 sr)]$, the limit value is not exceeded and it is not necessary to take into consideration the other limits. The source belongs to risk class 0.

If $L_{B_100} > 100 [W/(m^2 sr)]$, the limit is exceeded and the succeeding limit must be taken into consideration (the observation time is below 10000s, so even the minimum angular dimension that can be focused by the human eye becomes smaller, the succeeding limit is that with an angle of 11mrad).

- $t_{100} [s]$ time period during which a source can be observed without damages to the visual system.

If the preceding limit is not exceeded, t_{100} will be above 10000s; if this is below, the succeeding limit will have to be taken into consideration.

- L_B (11mrad) [$W/(m^2 \text{ sr})$] radiance calculated assuming that all light comes from a circular area whose angular dimension is 11mrad.

This is true if the observation time is above 10s and below 100s; in fact, for time periods within this interval the smallest source detected by the human eye is 11mrad (CEI IEC 62471).

If value $L_{B_{11}} \leq 10000$ [$W/(m^2 \text{ sr})$], the limit is not exceeded and the other limits have to be taken into consideration. The source belongs to risk class 1.

If $L_{B_{11}} > 10000$ [$W/(m^2 \text{ sr})$], the limit is exceeded and it is necessary to take into consideration the succeeding limit (the observation time is below 100s, so even the minimum angular dimension that can be focused by the human eye becomes smaller, the succeeding limit is that with an angle of 1.7mrad).

- t_{11} [s] time period during which the source can be observed without damages to the visual system.

If the preceding limit is not exceeded, t_{11} will be above 10s; if this is below, the succeeding limit will have to be taken into consideration.

- L_B (1.7mrad) [$W/(m^2 \text{ sr})$] radiance calculated assuming that all light comes from a circular area whose angular dimension is 1.7mrad.

This is true if the observation time is below 0.25s (CEI IEC 62471).

If value $L_{B_{1.7}} < 4 \cdot 10^6$ [$W/(m^2 \text{ sr})$], the limit is not exceeded. The source belongs to risk class 2.

In any case, the maximum exposure time can be calculated, that will always be below 0.25s.

- $t_{1.7}$ [s] t time period during which the source can be observed without damages to the visual system, calculated from $t_{1.7} = 10^6 / L_{B_{1.7}}$.

- **Alpha [rad]** , the user supplies the angular dimension of the source in radians or degrees:

- Alpha [rad] angle subtended by the source in radians or degrees.
- Omega [sr] solid angle subtended by the source, calculated starting from Alpha angle assuming that the source shape is circular:

$$\text{Omega} = 2\pi (1 - \cos(\text{Alpha}/2))$$

- L_B (100mrad) [$W/(m^2 \text{ sr})$] radiance calculated assuming that the source has an angular dimension of 100mrad.
- L_B (11mrad) [$W/(m^2 \text{ sr})$] radiance calculated assuming that the source has an angular dimension of 11mrad.
- L_B (1.7mrad) [$W/(m^2 \text{ sr})$] radiance calculated assuming that the source has an angular dimension of 1.7mrad.
- L_B (real) [$W/(m^2 \text{ sr})$] is the real radiance calculated starting from the entered geometric parameters.

- t_{lim} [s] exposure time limit, that is the time period during which the source can be observed with no problems to the visual system. This value is calculated with the following procedure:

$$\text{if } \alpha \geq 100\text{mrad} \Rightarrow \begin{cases} \text{if } L_{B_real} < 100 \text{ then } t_{lim} > 10000\text{s} \\ \hspace{10em} \text{(d index satisfied)} \\ \text{otherwise } t_{lim} = 10^6 / L_{B_real} \\ \hspace{10em} \text{(c index satisfied)} \end{cases}$$

$$\text{If } 11\text{mrad} \leq \alpha < 100\text{mrad} \Rightarrow \begin{cases} \text{if } L_{B_100} < 100 \text{ then } t_{lim} > 10000\text{s} \\ \hspace{10em} \text{(d index satisfied)} \\ \text{otherwise } t_{lim} = 10^6 / L_{B_real} \\ \hspace{10em} \text{(c index satisfied)} \end{cases}$$

$$\text{if } \alpha < 11\text{mrad} \Rightarrow \begin{cases} \text{if } L_{B_100} < 100 \text{ then } t_{lim} > 10000\text{s} \\ \hspace{10em} \text{(d index satisfied)} \\ \text{otherwise } t_{lim} = 10^6 / L_{B_11} \end{cases}$$

- **Omega [sr]** , the solid angle under which the source is seen by the instrument is supplied by the user:

- Alpha [rad] angle subtended by the source calculated starting from the Omega solid angle assuming that the source shape is circular:

$$\alpha = 2(\cos^{-1}(1 - \Omega/2\pi))$$

- Omega [sr] solid angle subtended by the source.
- L_B (100mrad) [W/(m² sr)] radiance calculated assuming that the source angular dimension is 100mrad.
- L_B (11mrad) [W/(m² sr)] radiance calculated assuming that the source angular dimension is 11mrad.
- L_B (1.7mrad) [W/(m² sr)] radiance calculated assuming that the source angular dimension is 1.7mrad.
- L_B (real) [W/(m² sr)] real radiance calculated starting from the entered geometric parameters.
- t_{lim} [s] exposure time limit, that is the time period during which the source can be observed with no problems to the visual system. This value is calculated with the following procedure:

$$\text{if } \alpha \geq 100\text{mrad} \Rightarrow \begin{cases} \text{if } L_{B_real} < 100 \text{ then } t_{lim} > 10000\text{s} \\ \hspace{10em} \text{(d index satisfied)} \\ \text{otherwise } = 10^6 / L_{B_real} \\ \hspace{10em} \text{(c index satisfied)} \end{cases}$$

$$\text{if } 11\text{mrad} \leq \text{Alpha} < 100\text{mrad} \Rightarrow \begin{cases} \text{if } L_{B_100} < 100 \text{ then } t_{\text{lim}} > 10000\text{s} \\ \hspace{10em} (\text{d index satisfied}) \\ \text{otherwise } t_{\text{lim}} = 10^6 / L_{B_real} \\ \hspace{10em} (\text{c index satisfied}) \end{cases}$$

$$\text{if } \text{Alpha} < 11\text{mrad} \Rightarrow \begin{cases} \text{if } L_{B_100} < 100 \text{ then } t_{\text{lim}} > 10000\text{s} \\ \hspace{10em} (\text{d index satisfied}) \\ \text{otherwise } t_{\text{lim}} = 10^6 / L_{B_11} \end{cases}$$

• **Side d1 [m] - Side d2 [m] – Distance R [m]:**

- Alpha_1 [rad] angle subtended by the source along side d1 (see following table).
- Alpha_2 [rad] angle subtended by the source along side d2 (see following table).

Note: Alpha_1 and Alpha_2 values are those perceived by the visual system and are calculated starting from α_1, α_2 angles calculated uniquely from geometric parameters.

α_1, α_2	Alpha_1	Alpha_2
$\alpha_1 \geq 100, \alpha_2 \geq 100$	$2 \times \text{Tan}^{-1}(d1/2R)$	$2 \times \text{Tan}^{-1}(d2/2R)$
$11 \leq \alpha_1 < 100, \alpha_2 \geq 100$	$2 \times \text{Tan}^{-1}(d1/2R)$	100mrad
$11 > \alpha_1, \alpha_2 \geq 100$	11mrad	100mrad
$11 > \alpha_1, 11 \leq \alpha_2 < 100$	11mrad	$2 \times \text{Tan}^{-1}(d2/2R)$
$11 \leq \alpha_1 < 100, 11 \leq \alpha_2 < 100$	$2 \times \text{Tan}^{-1}(d1/2R)$	$2 \times \text{Tan}^{-1}(d2/2R)$
$\alpha_1 \geq 100, 11 \leq \alpha_2 < 100$	100mrad	$2 \times \text{Tan}^{-1}(d2/2R)$
$11 > \alpha_1, 11 > \alpha_2$	11mrad	11mrad
$11 \leq \alpha_1 < 100, 11 > \alpha_2$	$2 \times \text{Tan}^{-1}(d1/2R)$	11mrad
$\alpha_1 \geq 100, 11 > \alpha_2$	100mrad	11mrad

- Alpha [rad] average angle subtended by the source calculated as the average of Alpha_1 e Alpha_2. This angle must be known to be able to calculate the real radiance perceived by human eye (CEI IEC 62471).
- Omega [sr] solid angle under which the rectangle is seen. Calculation can be performed rigorously or approximately.
- L_B (100mrad) [W/(m² sr)] radiance calculated assuming that the source angular dimension is 100mrad.
- L_B (11mrad) [W/(m² sr)] radiance calculated assuming that the source angular dimension is 11mrad.
- L_B (1.7mrad) [W/(m² sr)] radiance calculated assuming that the source angular dimension is 1.7mrad.
- L_B (real) [W/(m² sr)] real radiance calculated starting from the entered geometric parameters.

- t_{lim} [s] exposure time limit, that is the time period during which the source can be observed with no problems to the visual system. This value is calculated with the following procedure:

$$\text{if } \alpha \geq 100\text{mrad} \Rightarrow \begin{cases} \text{if } L_{B_real} < 100 \text{ then } t_{lim} > 10000\text{s} \\ \quad \text{(d index satisfied)} \\ \text{otherwise } t_{lim} = 10^6 / L_{B_real} \\ \quad \text{(c index satisfied)} \end{cases}$$

$$\text{if } 11\text{mrad} \leq \alpha < 100\text{mrad} \Rightarrow \begin{cases} \text{if } L_{B_100} < 100 \text{ then } t_{lim} > 10000\text{s} \\ \quad \text{(d index satisfied)} \\ \text{otherwise } t_{lim} = 10^6 / L_{B_real} \\ \quad \text{(c index satisfied)} \end{cases}$$

$$\text{if } \alpha < 11\text{mrad} \Rightarrow \begin{cases} \text{if } L_{B_100} < 100 \text{ then } t_{lim} > 10000\text{s} \\ \quad \text{(d index satisfied)} \\ \text{otherwise } t_{lim} = 10^6 / L_{B_11} \end{cases}$$

- **Diameter d [m] – Distance R [m]:**

- Alpha [rad] angle subtended by the source.
- Omega [sr] solid angle subtended by the source.
- L_B (100mrad) [W/(m² sr)] radiance calculated assuming that the source angular dimension is 100mrad.
- L_B (11mrad) [W/(m² sr)] radiance calculated assuming that the source angular dimension is 11mrad.
- L_B (1.7mrad) [W/(m² sr)] radiance calculated assuming that the source angular dimension is 1.7mrad.
- L_B (real) [W/(m² sr)] real radiance calculated starting from the entered geometric parameters.
- t_{lim} [s]: exposure time limit, that is the time period during which the source can be observed with no problems to the visual system. This value is calculated with the following procedure:

$$\text{if } \alpha \geq 100\text{mrad} \Rightarrow \begin{cases} \text{if } L_{B_real} < 100 \text{ then } t_{lim} > 10000\text{s} \\ \quad \text{(d index satisfied)} \\ \text{otherwise } t_{lim} = 10^6 / L_{B_real} \\ \quad \text{(c index satisfied)} \end{cases}$$

$$\text{if } 11\text{mrad} \leq \text{Alpha} < 100\text{mrad} \Rightarrow \begin{cases} \text{if } L_{B_{100}} < 100 \text{ then } t_{\text{lim}} > 10000\text{s} \\ \hspace{10em} \text{(d index satisfied)} \\ \text{otherwise } t_{\text{lim}} = 10^6 / L_{B_{\text{real}}} \\ \hspace{10em} \text{(c index satisfied)} \end{cases}$$

$$\text{If Alpha} < 11\text{mrad} \Rightarrow \begin{cases} \text{if } L_{B_{100}} < 100 \text{ then } t_{\text{lim}} > 10000\text{s} \\ \hspace{10em} \text{(d index satisfied)} \\ \text{otherwise } t_{\text{lim}} = 10^6 / L_{B_{11}} \end{cases}$$

The exposure time limit in seconds is displayed aside radiance values.

If the *Include in Report* box is selected, table data will be included in the final report.

6.4.6 Table g.h.i. 380-1400

Table **g.h.i. 380-1400** displays the exposure limit L_R for parameters "g", "h", "i".

Input data		Radiance LR	[W/(m ² sr)]	Time Limit [sec]
Irradiance [W/m ²]	1,000E+0	LR	1,329E+0	> 10 sec
Alpha [deg]	53,13E+0	LR @ 100 mrad	-	-
Alpha [rad]	927,3E-3	LR @ 1.7 mrad	-	-
Omega [sr]	805,4E-3			

Include in Report

The limit varies with respect to source observation time and to angular dimensions; consequently, different exposure limits correspond to different observation times and dimensions. In particular:

$$L_R = 2.8 \cdot 10^7 / C_\alpha \text{ [W m}^{-2} \text{ sr}^{-1}] \text{ for } t > 10\text{s (g limit)}$$

$$L_R = 5 \cdot 10^7 / (t^{0.25} C_\alpha) \text{ [W m}^{-2} \text{ sr}^{-1}] \text{ for } 10\mu\text{s} \leq t \leq 10\text{s (h limit)}$$

$$L_R = 8.89 \cdot 10^8 / C_\alpha \text{ [W m}^{-2} \text{ sr}^{-1}] \text{ for } t < 10\mu\text{s (i limit)}$$

C_α is a coefficient that depends on α dimensions of the source; its value is:

$$C_\alpha = 1.7 \quad \text{for } \alpha \leq 1.7\text{mrad}$$

$$C_\alpha = \alpha \quad \text{for } 1.7 \leq \alpha \leq 100\text{mrad}$$

$$C_\alpha = 100 \quad \text{for } \alpha > 100\text{mrad}$$

The displayed values are:

- E_r Irradiance value [W/m²] (corresponding to the instant value if a single sample is taken into consideration, and to the mean value if several samples are taken into consideration).
- Alpha angle in degrees, it is the angle under which the analyzed source is seen.

- Alpha angle in radians, equal to the previous but expressed in radians.
- Omega solid angle in steradians, it is the solid angle under which the analyzed source is seen. This angle is used for the calculation of luminance.

This parameter is estimated based on the radiance value and not on irradiance; consequently, the more detailed are the entered geometric parameters, the more plentiful will be the data on limit value.

All possible cases are analyzed in the following.

- **Geometric data not available:**

- L_R (100mrad) [W/(m² sr)] radiance calculated assuming that all the light comes from a circular area whose angular dimension is 100mrad. This value is to be compared with the three limit values.
- t_{lim100} [s] exposure time limit, that is the time period during which a source can be observed without damages to the visual system. This value is calculated with the following procedure (all radiance values are expressed in [W m⁻² sr⁻¹]):

it is assumed that $C_\alpha = 100$

if $L_{R_{100}} < 2.8 \cdot 10^5 \Rightarrow t_{lim} > 10s$ (g limit satisfied)

if $2.8 \cdot 10^5 \leq L_{R_{100}} \leq 8.89 \cdot 10^6 \Rightarrow t_{lim} = (5 \cdot 10^5 / L_{R_{100}})^4$ (h limit satisfied)

if $L_{R_{100}} > 8.89 \cdot 10^6 \Rightarrow t_{lim} < 10\mu s$ (i limit)

- L_R (1.7mrad) [W/(m² sr)] radiance calculated assuming that all light comes from a circular area whose angular dimension is 1.7mrad. This value is to be compared with the three limit values.
- $t_{lim1.7}$ [s] exposure limit time, that is the time period during which a source can be observed without damages to the visual system. This value is calculated with the following procedure (all radiance values are expressed in [W m⁻² sr⁻¹]):

it is assumed that $C_\alpha = 1.7$

if $L_{R_{1.7}} \leq 1.65 \cdot 10^7 \Rightarrow t_{lim} > 10s$ (g limit satisfied)

if $1.65 \cdot 10^7 \leq L_{R_{1.7}} \leq 5.2 \cdot 10^8 \Rightarrow t_{lim} = (2.94 \cdot 10^7 / L_{R_{1.7}})^4$ (h limit satisfied)

if $L_{R_{1.7}} > 5.2 \cdot 10^8 \Rightarrow t_{lim} < 10\mu s$ (i limit)

- **Alpha [rad]** , the user supplies the angular dimension of the source in radians.

- Alpha [rad] angle subtended by the source.
- Omega [sr] solid angle subtended by the source, calculated starting from Alpha angle, assuming that the source shape is circular:

$$\Omega = 2\pi(1 - \cos(\alpha/2))$$

- L_R (100mrad) [W/(m² sr)] radiance calculated assuming that the source angular dimension is 100mrad.
- L_R (1.7mrad) [W/(m² sr)] radiance calculated assuming that the source angular dimension is 1.7mrad.

- L_R (real) [$W/(m^2 sr)$] is the real radiance calculated starting from the entered geometric parameters.
- t_{lim} [s] exposure time limit, that is the time period during which a source can be observed without damages to the visual system. This value is calculated with the following procedure (all radiance values are expressed in [$W m^{-2} sr^{-1}$]):

if $\text{Alpha} > 100\text{mrad}$ it is assumed that $C_\alpha = 100$

if $L_{R_real} \leq 2.8 \cdot 10^5 \Rightarrow t > 10\text{s}$ (g limit satisfied)

if $2.8 \cdot 10^5 \leq L_{R_real} \leq 8.89 \cdot 10^6 \Rightarrow t_{lim} = (5 \cdot 10^5 / L_{R_real})^4$ [s] (h limit satisfied)

if $8.89 \cdot 10^6 \leq L_{R_real} \Rightarrow t_{lim} < 10\mu\text{s}$ (i limit)

if $1.7\text{mrad} < \text{Alpha} < 100\text{mrad}$ it is assumed that $C_\alpha = \text{Alpha}$

if $L_{R_real} \leq 2.8 \cdot 10^7 / \text{Alpha} \Rightarrow t > 10\text{s}$ (g limit satisfied)

if $2.8 \cdot 10^7 / \text{Alpha} \leq L_{R_real} \leq 8.89 \cdot 10^8 / \text{Alpha} \Rightarrow t_{lim} = (5 \cdot 10^7 / (L_{R_real} \cdot \text{Alpha}))^4$ [s]
(h limit satisfied)

if $8.89 \cdot 10^8 / \text{Alpha} \leq L_{R_real} \Rightarrow t_{lim} < 10\mu\text{s}$ (i limit)

if $\text{Alpha} < 1.7\text{mrad}$ it is assumed that $C_\alpha = 1.7$

if $L_{R_1.7} \leq 1.65 \cdot 10^7 \Rightarrow t > 10\text{s}$ (g limit satisfied)

if $1.65 \cdot 10^7 \leq L_{R_1.7} \leq 5.23 \cdot 10^8 \Rightarrow t_{lim} = (2.94 \cdot 10^7 / (L_{R_1.7}))^4$ [s] (h limit satisfied)

if $5.23 \cdot 10^8 \leq L_{R_1.7} \Rightarrow t_{lim} < 10\mu\text{s}$ (i limit)

• **Omega [sr]** , the solid angle under which the source is seen by the instrument in steradians is supplied by the user.

- Alpha [rad] angle subtended by the source calculated starting from Omega solid angle assuming that the source shape is circular:

$$\text{Alpha} = 2(\text{Cos}^{-1}(1 - \text{Omega}/2\pi))$$

- Omega [sr] solid angle subtended by the source.
- L_R (100mrad) [$W/(m^2 sr)$] radiance calculated assuming that the source angular dimension is 100mrad.
- L_R (1.7mrad) [$W/(m^2 sr)$] radiance calculated assuming that the source angular dimension is 1.7mrad.
- L_R (real) [$W/(m^2 sr)$] real radiance calculated starting from the entered geometric parameters.
- t_{lim} [s] exposure time limit, that is the time period during which a source can be observed without damages to the visual system. This value is calculated with the following procedure (all radiance values are expressed in [$W m^{-2} sr^{-1}$]):

if $\text{Alpha} > 100\text{mrad}$ it is assumed that $C_\alpha = 100$

if $L_{R_real} \leq 2.8 \cdot 10^5 \Rightarrow t > 10\text{s}$ (g limit satisfied)

if $2.8 \cdot 10^5 \leq L_{R_real} \leq 8.89 \cdot 10^6 \Rightarrow t_{lim} = (5 \cdot 10^5 / L_{R_100})^4$ [s] (h limit satisfied)

if $8.89 \cdot 10^6 \leq L_{r_real} \Rightarrow t_{lim} < 10\mu\text{s}$ (i limit)

if $1.7\text{mrad} < \text{Alpha} < 100\text{mrad}$ it is assumed that $C_\alpha = \text{Alpha}$

if $L_{R_real} \leq 2.8 \cdot 10^7 / \text{Alpha} \Rightarrow t > 10\text{s}$ (g limit satisfied)

if $2.8 \cdot 10^7 / \text{Alpha} \leq L_{R_real} \leq 8.89 \cdot 10^8 / \text{Alpha} \Rightarrow t_lim = (5 \cdot 10^7 / (L_{R_real} \cdot \text{Alpha}))^4 [\text{s}]$
(h limit satisfied)

if $8.89 \cdot 10^8 / \text{Alpha} \leq L_{R_real} \Rightarrow t_lim < 10\mu\text{s}$ (i limit)

if $\text{Alpha} < 1.7\text{mrad}$ it is assumed that $C_\alpha = 1.7$

if $L_{R_1.7} \leq 1.65 \cdot 10^7 \Rightarrow t > 10\text{s}$ (g limit satisfied)

if $1.65 \cdot 10^7 \leq L_{R_1.7} \leq 5.23 \cdot 10^8 \Rightarrow t_lim = (2.94 \cdot 10^7 / (L_{R_1.7}))^4 [\text{s}]$ (h limit satisfied)

if $5.23 \cdot 10^8 \leq L_{R_1.7} \Rightarrow t_lim < 10\mu\text{s}$ (i limit)

• **Side d1 [m] - Side d2 [m] – Distance R [m]:**

- Alpha_1 [rad] angle subtended by the source along side d1 (see following table).
- Alpha_2 [rad] angle subtended by the source along side d2 (see following table).

Note: Alpha_1 and Alpha_2 values are those perceived by the visual system and are calculated starting from α_1, α_2 angles calculated uniquely from geometric parameters.

α_1, α_2	Alpha_1	Alpha_2
$\alpha_1 > 100, \alpha_2 > 100$	$2 \times \text{Tan}^{-1}(d1/2R)$	$2 \times \text{Tan}^{-1}(d2/2R)$
$1.7 \leq \alpha_1 \leq 100, \alpha_2 > 100$	$2 \times \text{Tan}^{-1}(d1/2R)$	100mrad
$1.7 > \alpha_1, \alpha_2 > 100$	1.7mrad	100mrad
$1.7 > \alpha_1, 11 \leq \alpha_2 < 100$	1.7mrad	$2 \times \text{Tan}^{-1}(d2/2R)$
$1.7 \leq \alpha_1 < 100, 1.7 \leq \alpha_2 \leq 100$	$2 \times \text{Tan}^{-1}(d1/2R)$	$2 \times \text{Tan}^{-1}(d2/2R)$
$\alpha_1 > 100, 1.7 \leq \alpha_2 \leq 100$	100mrad	$2 \times \text{Tan}^{-1}(d2/2R)$
$1.7 > \alpha_1, 1.7 > \alpha_2$	1.7mrad	1.7mrad
$1.7 < \alpha_1 < 100, 1.7 > \alpha_2$	$2 \times \text{Tan}^{-1}(d1/2R)$	1.7mrad
$\alpha_1 > 100, 11 > \alpha_2$	100mrad	1.7mrad

- Alpha [rad] average angle subtended by the source calculated as the average of Alpha_1 e Alpha_2. This angle must be known to be able to calculate the real radiance perceived by human eye (CEI IEC 62471).
- Omega [sr] solid angle under which the rectangle is seen. Calculation can be performed rigorously or approximately.
- L_B (100mrad) [W/(m² sr)] radiance calculated assuming that the source angular dimension is 100mrad.
- L_R (1.7mrad) [W/(m² sr)] radiance calculated assuming that the source angular dimension is 1.7mrad.
- L_R (real) [W/(m² sr)] real radiance calculated starting from the entered geometric parameters.
- t_lim [s] exposure time limit, that is the time period during which a source can be observed without damages to the visual system. This value is calculated with the following procedure:

if $\text{Alpha} > 100\text{mrad}$ it is assumed that $C_\alpha = 100$

if $L_{R_real} \leq 2.8 \cdot 10^5 \Rightarrow t > 10\text{s}$ (g limit satisfied)

if $2.8 \cdot 10^5 \leq L_{R_real} \leq 8.89 \cdot 10^6 \Rightarrow t_lim = (5 \cdot 10^5 / L_{R_100})^4$ [s] (h limit satisfied)

if $8.89 \cdot 10^6 \leq L_{R_real} \Rightarrow t_lim < 10\mu\text{s}$ (i limit)

if $1.7\text{mrad} \leq \text{Alpha} < 100\text{mrad}$ it is assumed that $C_\alpha = \text{Alpha}$

if $L_{R_real} \leq 2.8 \cdot 10^7 / \text{Alpha} \Rightarrow t > 10\text{s}$ (g limit satisfied)

if $2.8 \cdot 10^7 / \text{Alpha} \leq L_{R_real} \leq 8.89 \cdot 10^8 / \text{Alpha} \Rightarrow t_lim = (5 \cdot 10^7 / (L_{R_real} \cdot \text{Alpha}))^4$ [s]
(h limit satisfied)

if $8.89 \cdot 10^8 / \text{Alpha} \leq L_{R_real} \Rightarrow t_lim < 10\mu\text{s}$ (i limit)

• **Diameter d [m] – Distance R [m]:**

- Alpha [rad] angle subtended by the source.
- Omega [sr] solid angle subtended by the source.
- L_R (100mrad) [W/(m² sr)] radiance calculated assuming that the source angular dimension is 100mrad.
- L_R (1.7mrad) [W/(m² sr)] radiance calculated assuming that the source angular dimension is 1.7mrad.
- L_R (real) [W/(m² sr)] real radiance calculated starting from the entered geometric parameters.
- t_lim [s] exposure time limit, that is the time period during which a source can be observed without damages to the visual system. This value is calculated with the following procedure:

if $\text{Alpha} > 100\text{mrad}$ it is assumed that $C_\alpha = 100$

if $L_{R_real} \leq 2.8 \cdot 10^5 \Rightarrow t > 10\text{s}$ (g limit satisfied)

if $2.8 \cdot 10^5 \leq L_{R_real} \leq 8.89 \cdot 10^6 \Rightarrow t_lim = (5 \cdot 10^5 / L_{R_100})^4$ [s] (h limit satisfied)

if $8.89 \cdot 10^6 \leq L_{R_real} \Rightarrow t_lim < 10\mu\text{s}$ (i limite)

if $1.7\text{mrad} < \text{Alpha} < 100\text{mrad}$ it is assumed that $C_\alpha = \text{Alpha}$

if $L_{R_real} \leq 2.8 \cdot 10^7 / \text{Alpha} \Rightarrow t > 10\text{s}$ (g limit satisfied)

if $2.8 \cdot 10^7 / \text{Alpha} \leq L_{R_real} \leq 8.89 \cdot 10^8 / \text{Alpha} \Rightarrow t_lim = (5 \cdot 10^7 / (L_{R_real} \cdot \text{Alpha}))^4$ [s]
(h limit satisfied)

if $8.89 \cdot 10^8 / \text{Alpha} \leq L_{R_real} \Rightarrow t_lim < 10\mu\text{s}$ (i limit)

if $\text{Alpha} < 1.7\text{mrad}$ it is assumed that $C_\alpha = 1.7$

if $L_{R_1.7} \leq 1.65 \cdot 10^7 \Rightarrow t > 10\text{s}$ (g limit satisfied)

if $1.65 \cdot 10^7 \leq L_{R_1.7} \leq 5.23 \cdot 10^8 \Rightarrow t_lim = (2.94 \cdot 10^7 / (L_{R_1.7}))^4$ [s] (h limit satisfied)

if $5.23 \cdot 10^8 \leq L_{R_1.7} \Rightarrow t_lim < 10\mu\text{s}$ (i limit)

The exposure limit time in seconds is displayed aside radiance values.

If the *Include in Report* box is selected, table data will be included in the final report.

6.4.7 Table j.k.l. 780-1400

Table j.k.l. 780-1400 shows L_R exposure limit for parameters "j", "k", "l".

Lux/Lum		a. 180-400	b. 315-400	c.d. 300-700	g.h.i. 380-1400	j.k.l. 780-1400	m.n.o. 380-3000	Notes	Report
Risk indexes: j k l									
Input data		Radiance LR		[W/(m ² sr)]		Time Limit [sec]			
Irradiance [W/m ²]	1,000E+0	LR	1,329E+0	> 10 sec					
Alpha [deg]	53,13E+0	LR @ 100 mrad	-	-					
Alpha [rad]	927,3E-3	LR @ 11 mrad	-	-					
Omega [sr]	805,4E-3								
<input checked="" type="checkbox"/> Include in Report									

The limit varies according to source observation time and to angular dimensions; consequently, different exposure limits correspond to different observation times and dimensions. In particular:

$$L_R = 6.6 \cdot 10^6 / C_\alpha \text{ [W m}^{-2} \text{ sr}^{-1}] \quad \text{for } t > 10\text{s (j limit)}$$

$$L_R = 5 \cdot 10^7 / (t^{0.25} C_\alpha) \text{ [W m}^{-2} \text{ sr}^{-1}] \quad \text{for } 10\mu\text{s} \leq t \leq 10\text{s (k limit)}$$

$$L_R = 8.89 \cdot 10^8 / C_\alpha \text{ [W m}^{-2} \text{ sr}^{-1}] \quad \text{for } t < 10\mu\text{s (l limit)}$$

C_α is a coefficient that depends from source α dimensions; its value is:

$$C_\alpha = 11 \quad \text{for } \alpha \leq 11\text{mrad}$$

$$C_\alpha = \alpha \quad \text{for } 11 \leq \alpha \leq 100\text{mrad}$$

$$C_\alpha = 100 \quad \text{for } \alpha > 100\text{mrad}$$

The displayed values are:

- Irradiance value E_r [W/m²] (corresponds to the instant value if a single sample is considered, or to the mean value if several samples are considered).
- Alpha angle in degrees, it is the angle under which the analyzed source is seen.
- Alpha angle in radians, equal to the previous angle, but expressed in radians.
- Omega solid angle in steradians, a solid angle under which the analyzed source is seen. This angle is used for the calculation of luminance.

This parameter is estimated based on the radiance value and not on that of irradiance, so the more detailed are the entered geometric parameters, the more plentiful will be the data on limit value.

All possible cases are analyzed in the following.

- **Geometric data not available:**

- L_r (100mrad) [W/(m² sr)] radiance calculated assuming that all the light comes from a circular area whose angular dimension is 100mrad. This value is to be compared with the three limit values.
- $t_{\text{lim}100}$ [s] exposure limit time, that is the time period during which a source can be observed without damages to the visual system. This value is calculated with the following procedure (all radiance values are expressed in [W m⁻² sr⁻¹]):

it is assumed that $C_\alpha = 100$

if $L_{r_{100}} < 6 \cdot 10^4 \Rightarrow t_{lim} > 10s$ (j limit satisfied)

if $2.8 \cdot 10^5 \leq L_{r_{100}} \leq 8.89 \cdot 10^6 \Rightarrow t_{lim} = (5 \cdot 10^5 / L_{r_{100}})^4$ (k limit satisfied)

if $L_{r_{100}} < 8.89 \cdot 10^6 \Rightarrow t_{lim} < 10\mu s$ (l limit)

- L_r (11mrad) [W/(m² sr)] radiance calculated assuming that all the light comes from a circular area whose angular dimension is 11mrad. This value is to be compared with the three limit values.

- t_{lim11} [s] exposure limit time, that is the time period during which a source can be observed without damages to the visual system. This value is calculated with the following procedure (all radiance values are expressed in [W m⁻² sr⁻¹]):

it is assumed that $C_\alpha = 11$

if $L_{R_{11}} \leq 5.45 \cdot 10^5 \Rightarrow t_{lim} > 10s$ (j limit satisfied)

if $5.45 \cdot 10^5 \leq L_{R_{11}} \leq 8.08 \cdot 10^7 \Rightarrow t_{lim} = (4.54 \cdot 10^6 / L_{R_{11}})^4$ (k limit satisfied)

if $L_{R_{11}} > 8.08 \cdot 10^7 \Rightarrow t_{lim} < 10\mu s$ (l limit)

- **Alpha [rad]** , angular dimension of the source in radiants supplied by the user.

- Alpha [rad] angle subtended by the source.

- Omega [sr] solid angle subtended by the source, calculated starting from Alpha angle, assuming that the source shape is circular:

$$\Omega = 2\pi(1 - \cos(\alpha/2))$$

- L_R (100mrad) [W/(m² sr)] radiance calculated assuming that the source angular dimension is 100mrad.

- L_R (11mrad) [W/(m² sr)] radiance calculated assuming that the source angular dimension is 11mrad.

- L_R (real) [W/(m² sr)] is the real radiance calculated starting from the entered geometric parameters.

- t_{lim} [s] exposure limit time, that is the time period during which a source can be observed without damages to the visual system. This value is calculated with the following procedure (all radiance values are expressed in [W m⁻² sr⁻¹]):

if Alpha > 100mrad it is assumed that $C_\alpha = 100$

if $L_{R_{real}} \leq 6 \cdot 10^4 \Rightarrow t > 10s$ (j limit satisfied)

if $6 \cdot 10^4 \leq L_{R_{real}} \leq 8.89 \cdot 10^6 \Rightarrow t_{lim} = (5 \cdot 10^5 / L_{R_{real}})^4$ [s] (k limit satisfied)

if $8.89 \cdot 10^6 \leq L_{R_{real}} \Rightarrow t_{lim} < 10\mu s$ (l limit)

if 11mrad < Alpha < 100mrad it is assumed that $C_\alpha = \text{Alpha}$

if $L_{R_{real}} \leq 6 \cdot 10^6 / \text{Alpha} \Rightarrow t > 10s$ (j limit satisfied)

if $6 \cdot 10^6 / \text{Alpha} \leq L_{R_{real}} \leq 8.89 \cdot 10^8 / \text{Alpha} \Rightarrow t_{lim} = (5 \cdot 10^7 / (L_{R_{real}} \cdot \text{Alpha}))^4$ [s]
(k limit satisfied)

if $8.89 \cdot 10^8 / \text{Alpha} \leq L_{R_{real}} \Rightarrow t_{lim} < 10\mu s$ (l limit)

if $\text{Alpha} < 11\text{mrad}$ it is assumed that $C_\alpha = 11$

if $L_{R_11} \leq 5.45 \cdot 10^5 \Rightarrow t > 10\text{s}$ (j limit satisfied)

if $5.45 \cdot 10^5 \leq L_{R_11} \leq 8.08 \cdot 10^7 \Rightarrow t_{\text{lim}} = (4.54 \cdot 10^6 / (L_{R_11}))^4$ [s] (k limit satisfied)

if $8.08 \cdot 10^7 \leq L_{R_real} \Rightarrow t_{\text{lim}} < 10\mu\text{s}$ (l limite I)

• **Omega [sr]**, the solid angle under which the source is seen by the instrument in steradians is supplied by the user.

- Alpha [rad] angle subtended by the source calculated starting from Omega solid angle assuming that the source shape is circular:

$$\text{Alpha} = 2(\text{Cos}^{-1}(1 - \text{Omega}/2\pi))$$

- Omega [sr] solid angle subtended by the source.
- L_R (100mrad) [W/(m² sr)] radiance calculated assuming that the source angular dimension is 100mrad.
- L_R (11mrad) [W/(m² sr)] radiance calculated assuming that the source angular dimension is 11mrad.
- L_R (real) [W/(m² sr)] real radiance calculated starting from the entered geometric parameters.
- t_{lim} [s] exposure limit time, that is the time period during which a source can be observed without damages to the visual system. This value is calculated with the following procedure (all radiance values are expressed in [W m⁻² sr⁻¹]):

if $\text{Alpha} > 100\text{mrad}$ it is assumed that $C_\alpha = 100$

if $L_{R_real} \leq 6 \cdot 10^4 \Rightarrow t > 10\text{s}$ (j limit satisfied)

if $6 \cdot 10^4 \leq L_{R_real} \leq 8.89 \cdot 10^6 \Rightarrow t_{\text{lim}} = (5 \cdot 10^5 / L_{R_real})^4$ [s] (k limit satisfied)

if $8.89 \cdot 10^6 \leq L_{R_real} \Rightarrow t_{\text{lim}} < 10\mu\text{s}$ (l limit)

if $11\text{mrad} < \text{Alpha} < 100\text{mrad}$ it is assumed that $C_\alpha = \text{Alpha}$

if $L_{R_real} \leq 6 \cdot 10^6 / \text{Alpha} \Rightarrow t > 10\text{s}$ (j limit satisfied)

if $6 \cdot 10^6 / \text{Alpha} \leq L_{R_real} \leq 8.89 \cdot 10^8 / \text{Alpha} \Rightarrow t_{\text{lim}} = (5 \cdot 10^7 / (L_{R_real} \cdot \text{Alpha}))^4$ [s] (k limit satisfied)

if $8.89 \cdot 10^8 / \text{Alpha} \leq L_{R_real} \Rightarrow t_{\text{lim}} < 10\mu\text{s}$ (l limit)

if $\text{Alpha} < 11\text{mrad}$ it is assumed that $C_\alpha = 11$

if $L_{R_11} \leq 5.45 \cdot 10^5 \Rightarrow t > 10\text{s}$ (j limit satisfied)

if $5.45 \cdot 10^5 \leq L_{R_11} \leq 8.08 \cdot 10^7 \Rightarrow t_{\text{lim}} = (4.54 \cdot 10^6 / (L_{R_11}))^4$ [s] (k limit satisfied)

if $8.08 \cdot 10^7 \leq L_{R_real} \Rightarrow t_{\text{lim}} < 10\mu\text{s}$ (l limit)

• **Side d1 [m] - Side d2 [m] – Distance R [m]:**

- Alpha_1 [rad] angle subtended by the source along side d1 (see following table).
- Alpha_2 [rad] angle subtended by the source along side d2 (see following table).

Note: Alpha_1 and Alpha_2 values are those perceived by the visual system and are calculated starting from α_1, α_2 angles calculated uniquely from geometric parameters.

α_1, α_2	Alpha_1	Alpha_2
$\alpha_1 > 100, \alpha_2 > 100$	$2 \times \tan^{-1}(d1/2R)$	$2 \times \tan^{-1}(d2/2R)$
$11 \leq \alpha_1 \leq 100, \alpha_2 > 100$	$2 \times \tan^{-1}(d1/2R)$	100mrad
$11 > \alpha_1, \alpha_2 > 100$	11mrad	100mrad
$11 > \alpha_1, 11 \leq \alpha_2 \leq 100$	11mrad	$2 \times \tan^{-1}(d2/2R)$
$11 \leq \alpha_1 \leq 100, 11 \leq \alpha_2 \leq 100$	$2 \times \tan^{-1}(d1/2R)$	$2 \times \tan^{-1}(d2/2R)$
$\alpha_1 > 100, 11 < \alpha_2 < 100$	100mrad	$2 \times \tan^{-1}(d2/2R)$
$11 > \alpha_1, 11 > \alpha_2$	11mrad	11mrad
$11 < \alpha_1 < 100, 11 > \alpha_2$	$2 \times \tan^{-1}(d1/2R)$	11mrad
$\alpha_1 > 100, 11 > \alpha_2$	100mrad	11mrad

- Alpha [rad] average angle subtended by the source calculated as the average of Alpha_1 e Alpha_2. This angle must be known to be able to calculate the real radiance perceived by human eye (CEI IEC 62471).
- Omega [sr] solid angle under which the rectangle is seen. Calculation can be performed rigorously or approximately.
- L_B (100mrad) [W/(m² sr)] radiance calculated assuming that the source angular dimension is 100mrad.
- L_R (11mrad) [W/(m² sr)] radiance calculated assuming that the source angular dimension is 11mrad.
- L_R (real) [W/(m² sr)] real radiance calculated starting from the entered geometric parameters.
- t_{lim} [s] exposure time limit, that is the time period during which a source can be observed without damages to the visual system. This value is calculated with the following procedure:

if Alpha > 100mrad it is assumed that $C_\alpha = 100$

if $L_{R_real} \leq 6 \cdot 10^4 \Rightarrow t > 10s$ (j limit satisfied)

if $6 \cdot 10^4 \leq L_{R_real} \leq 8.89 \cdot 10^6 \Rightarrow t_{lim} = (5 \cdot 10^5 / L_{R_real})^4$ [s] (k limit satisfied)

if $8.89 \cdot 10^6 \leq L_{R_real} \Rightarrow t_{lim} < 10\mu s$ (l limit)

if 11mrad < Alpha < 100mrad it is assumed that $C_\alpha = \text{Alpha}$

if $L_{R_real} \leq 6 \cdot 10^6 / \text{Alpha} \Rightarrow t > 10s$ (j limit satisfied)

if $6 \cdot 10^6 / \text{Alpha} \leq L_{R_real} \leq 8.89 \cdot 10^8 / \text{Alpha} \Rightarrow t_{lim} = (5 \cdot 10^7 / (L_{R_real} \cdot \text{Alpha}))^4$ [s]
(k limit satisfied)

if $8.89 \cdot 10^8 / \text{Alpha} \leq L_{R_real} \Rightarrow t_{lim} < 10\mu s$ (l limit)

● **Diameter d [m] – Distance R [m]:**

- Alpha [rad] angle subtended by the source.
- Omega [sr] solid angle subtended by the source.
- L_R (100mrad) [W/(m² sr)] radiance calculated assuming that the source angular dimension is 100mrad.

- L_R (11mrad) [W/(m² sr)] radiance calculated assuming that the source angular dimension is 11mrad.
- L_R (real) [W/(m² sr)] real radiance calculated starting from the entered geometric parameters.
- t_{lim} [s] exposure time limit, that is the time period during which a source can be observed without damages to the visual system. This value is calculated with the following procedure:
 - if $\text{Alpha} > 100\text{mrad}$ it is assumed that $C_\alpha = 100$
 - if $L_{R_real} \leq 6 \cdot 10^4 \Rightarrow t > 10\text{s}$ (j limit satisfied)
 - if $6 \cdot 10^4 \leq L_{R_real} \leq 8.89 \cdot 10^6 \Rightarrow t_{lim} = (5 \cdot 10^5 / L_{R_real})^4$ [s] (k limit satisfied)
 - if $8.89 \cdot 10^6 \leq L_{R_real} \Rightarrow t_{lim} < 10\mu\text{s}$ (l limit)
 - if $11\text{mrad} < \text{Alpha} < 100\text{mrad}$ it is assumed that $C_\alpha = \text{Alpha}$
 - if $L_{R_real} \leq 6 \cdot 10^6 / \text{Alpha} \Rightarrow t > 10\text{s}$ (j limit satisfied)
 - if $6 \cdot 10^6 / \text{Alpha} \leq L_{R_real} \leq 8.89 \cdot 10^8 / \text{Alpha} \Rightarrow t_{lim} = (5 \cdot 10^7 / (L_{R_real} \cdot \text{Alpha}))^4$ [s] (k limit satisfied)
 - if $8.89 \cdot 10^8 / \text{Alpha} \leq L_{R_real} \Rightarrow t_{lim} < 10\mu\text{s}$ (l limit)
 - if $\text{Alpha} < 11\text{mrad}$ it is assumed that $C_\alpha = 11$
 - if $L_{R_11} \leq 5.45 \cdot 10^5 \Rightarrow t > 10\text{s}$ (j limit satisfied)
 - if $5.45 \cdot 10^5 \leq L_{R_11} \leq 8.08 \cdot 10^7 \Rightarrow t_{lim} = (4.54 \cdot 10^6 / (L_{R_11}))^4$ [s] (k limit satisfied)
 - if $8.08 \cdot 10^7 \leq L_{R_real} \Rightarrow t_{lim} < 10\mu\text{s}$ (l limit)

The exposure limit time in seconds is displayed aside radiance values.

If the *Include in Report* box is selected, table data will be included in the final report.

6.4.8 Table m.n.o. 380-3000

Table m.n.o. 380-3000 shows the exposure limits for parameters "m", "n", "o".

Lux/Lum	a. 180-400	b. 315-400	c.d. 300-700	g.h.i. 380-1400	j.k.l. 780-1400	m.n.o. 380-3000	Notes	Report
Risk indexes: m n o								
Input data			Indexes			Result		
Irradiance [W/m ²]	1,000E+0		o.			> 10 sec		
Dose [J/m ²]	1,000E+0		m.n.			> 1000 sec		
<input checked="" type="checkbox"/> Include in Report								

The displayed values are:

- E_{skin} [W/m²] irradiance value (corresponding to the instant value if a single sample is taken into consideration, and to the mean value if several samples are taken into consideration).
- H_{skin} [J/m²] dose value regarding the samples taken into consideration.
- Exposure time limit (t_{lim}) for "o" index necessary for exceeding the threshold, calculated with the following formula:

$$t_{lim} = 35600/E_{skin} \quad \text{if the found time is } > 10s$$

otherwise:

$$t_{lim} = (20000/ E_{skin})^{4/3}$$

- Exposure time limit (t_{lim}) for indexes "m" and "n"

Limits "m" and "n" should be calculated in the 780-3000 spectral interval. Since this spectral range is not available in the instrument, the same channel of the "o" limit is used; in this case, values will be greater than real values and consequently they will be in favor of worker safety.

As to exposure times greater than 1000 seconds, the "n" limit is calculated:

if $E_{IR} \leq 100 \text{ W/m}^2$ then the "n" limit is not satisfied;

if $E_{IR} > 100 \text{ W/m}^2$ then the exposure time is calculated in order to return back within "n" limit, in particular:

$$t_{lim} = (18000/ E_{IR})^{4/3}$$

If the *Include in Report* box is selected, the data in the table will be included in the final report.

6.4.9 Notes table

The user can record at will any comments regarding each of the limits provided for in attachment 37 of L.D. 81/08 in the *Notes* table.

Lux/Lum		a. 180-400	b. 315-400	c.d. 300-700	g.h.i. 380-1400	j.k.l. 780-1400	m.n.o. 380-3000	Notes	Report
Indexes	Notes								
a.									
b.									
c.d.									
g.h.i.									
j.k.l.									
m.n.o.									

6.4.10 Report table

The *Report* table sums up the exposure limit values for each risk index.

Lux/Lum		a. 180-400	b. 315-400	c.d. 300-700	g.h.i. 380-1400	j.k.l. 780-1400	m.n.o. 380-3000	Notes	Report
Indexes	Measured Parameter	Maximum Permitted Exposure (MPE)				Assessment			
<input checked="" type="checkbox"/>	a. 180-400 Irradiance [W/m ²] = 1,000E+0 Dose [J/m ²] = 1,000E+0	Time Limit [hh:mm:ss] = 00:00:30				a			
<input checked="" type="checkbox"/>	b. 315-400 Irradiance [W/m ²] = 1,000E+0 Dose [J/m ²] = 1,000E+0	Time Limit [hh:mm:ss] = 02:46:40				b			
<input checked="" type="checkbox"/>	c.d. 300-700 LB = 1,329E+0 [W/(m ² sr)]	Time Limit [sec] = > 24 hours				c d			
<input checked="" type="checkbox"/>	g.h.i. 380-1400 LR = 1,329E+0 [W/(m ² sr)]	Time Limit [sec] = > 10 sec				g h i			
<input checked="" type="checkbox"/>	j.k.l. 780-1400 LR = 1,329E+0 [W/(m ² sr)]	Time Limit [sec] = > 10 sec				j k l			
<input checked="" type="checkbox"/>	m.n.o. 380-3000 Irradiance [W/m ²] = 1,000E+0 Dose [J/m ²] = 1,000E+0	o. = > 10 sec m.n. = > 1000 sec				m n o			

Undetermined
 OK
 Danger
 Attention

In the *Assessment* column, the risk index state is indicated by means of colored boxes having the following significance:

- White box = risk index not determined
- Green box = risk index not exceeded
- Yellow box = risk index with limited exposure time
- Red box = risk index exceeded

The following table describes the association between box color and exposure time for the different indexes.

Risk index	Exposure time (t_lim)		
	Green box	Yellow box	Red box
a	t_lim > 8h	-	t_lim < 8h
b	t_lim > 8h	-	t_lim < 8h
c	t_lim > 10000s	t_lim < 10000s	-
d	t_lim > 10000s	-	t_lim < 10000s
g	t_lim > 10s	-	t_lim < 10s
h	t_lim > 10s	t_lim < 10s	t_lim < 10μs
i	t_lim > 10s	t_lim < 10s	-
j	t_lim > 10s	-	t_lim < 10s
k	t_lim > 10s	t_lim < 10s	t_lim < 10μs
l	t_lim > 10s	t_lim < 10s	-
m	t_lim > 1000s	t_lim < 1000s	-
n	t_lim > 1000s	-	t_lim < 1000s
o	t_lim > 10s	t_lim < 10s	-

Table 6: correspondence between evaluation of risk indexes and exposure time

7 SPECTRAL CHARACTERISTICS

Measurements of artificial optical radiations are conducted on a wide spectral interval ranging within 180nm and 3000nm.

Different risk indexes are associated to different spectral intervals, depending on the kind of damage produced by the optical radiation on the exposed parts of the human body: eyes and skin.

The correct curves of the spectral response are obtained by summing up the signals coming from several sensors with appropriate weighting.

7.1 SPECTRAL INTERVAL 180-400nm

This spectral interval must be evaluated with the weighting curve $S(\lambda)$.

The following figure shows the comparison between the spectral response curve obtained by the combination of channels and weighting curve $S(\lambda)$.

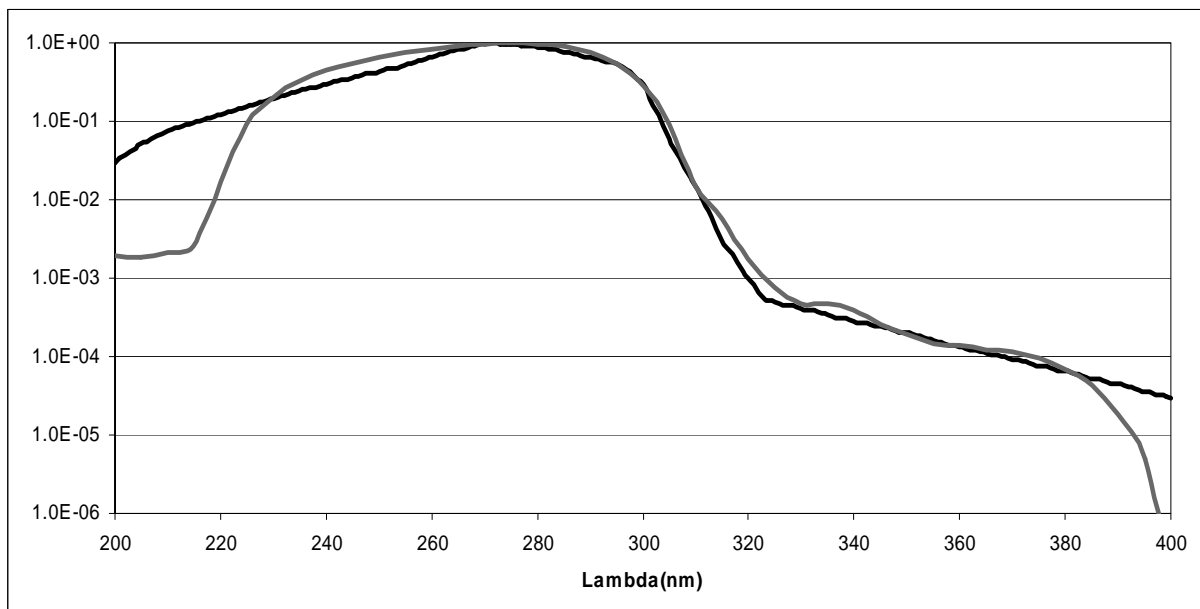

Figure 7: comparison between spectral response curve obtained by the combination of channels (in purple color) and weighting curve $S(\lambda)$ (in black)

7.2 SPECTRAL INTERVAL 315-400nm (UVA)

No weighting is required by this spectral interval.

The following figure shows the spectral response curve of the UVA channel.

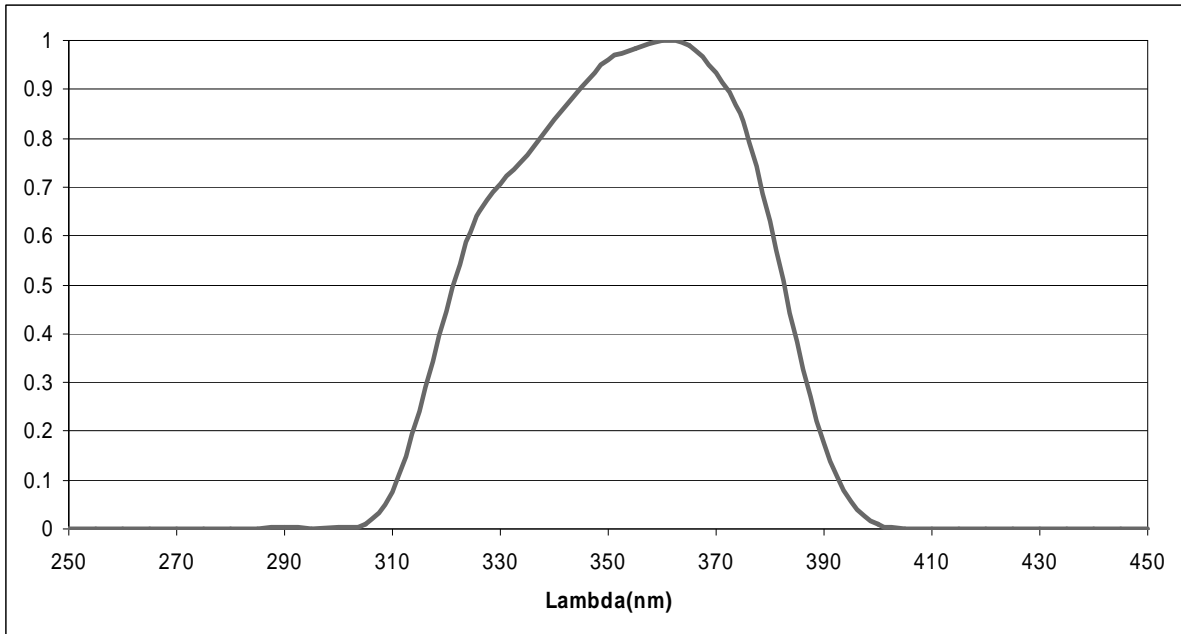

Figure 8: spectral response curve of UVA sensor

7.3 SPECTRAL INTERVAL 300-700nm

This spectral interval must be evaluated with the weighting curve $B(\lambda)$.

The following figure shows the comparison between the spectral response curve obtained by the combination of channels and weighting curve $B(\lambda)$.

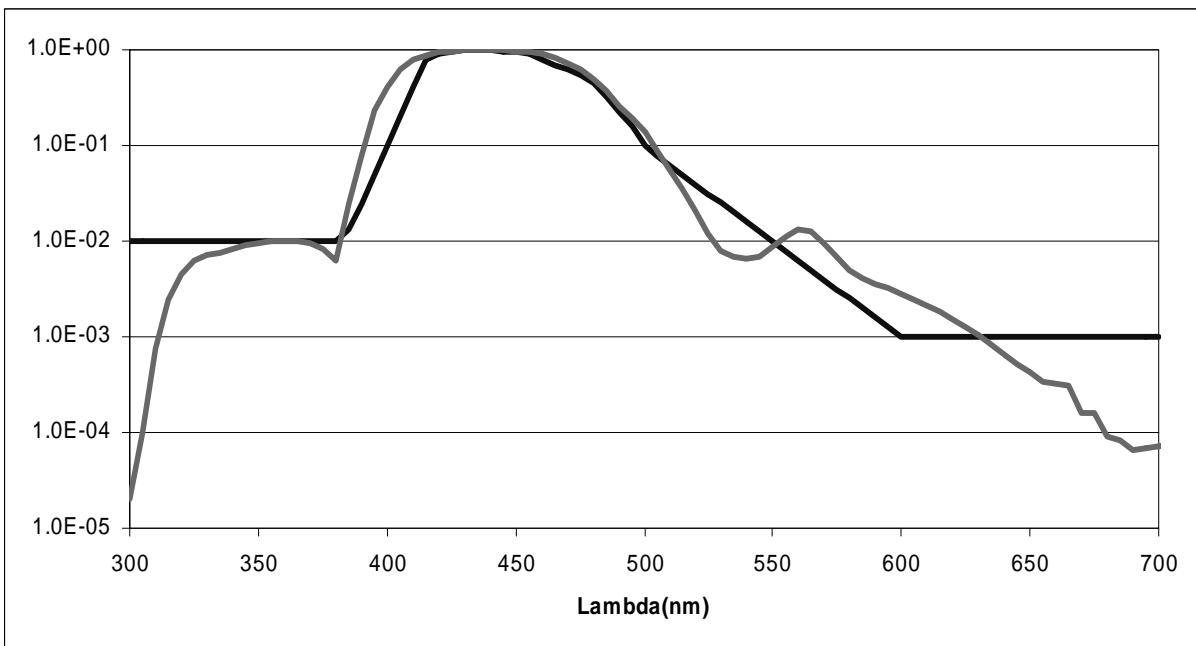

Figure 9: comparison between spectral response curve obtained by the combination of channels (in purple color) and weighting curve $B(\lambda)$ (in black)

7.4 SPECTRAL INTERVAL 380-1400nm

This spectral interval must be evaluated with the weighting curve $R(\lambda)$.

The following figure shows the comparison between the spectral response curve obtained by the combination of channels and weighting curve $R(\lambda)$.

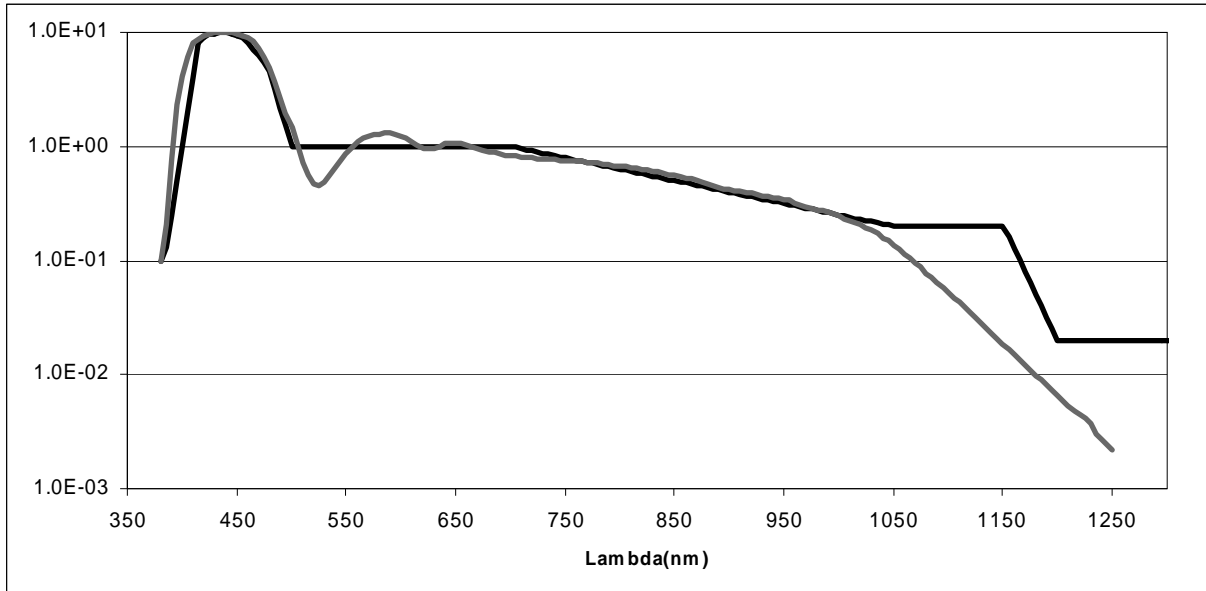

Figure 10: comparison between spectral response curve obtained by the combination of channels (purple color) and weighting curve $R(\lambda)$ (in black)

7.5 SPECTRAL INTERVAL 780-1400nm

This spectral interval must be evaluated with the weighting curve $R(\lambda)$ (in the only portion ranging from 780nm to 1400nm).

The following figure shows the comparison between the spectral response curve obtained by the combination of channel and weighting curve $R(\lambda)$.

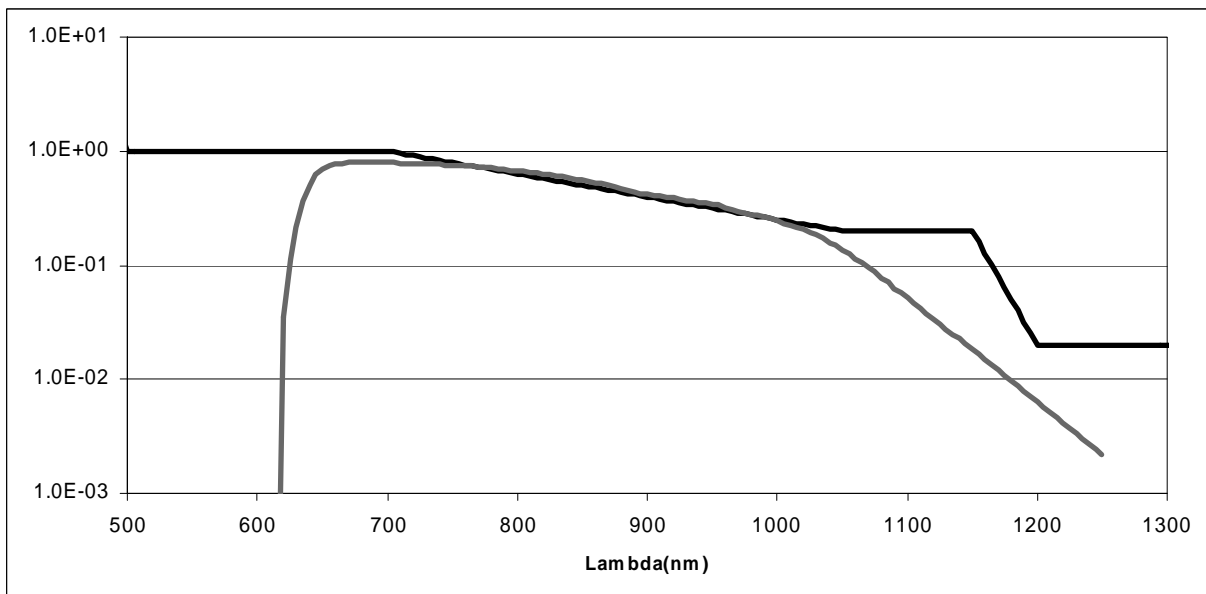

Figure 11: comparison between spectral response curve obtained by the combination of channels (purple color) and weighting curve $R(\lambda)$ (in black)

7.6 SPECTRAL INTERVAL 380-3000nm

No weighting is required by this spectral interval.

The following figure shows the spectral response curve of the pyranometer.

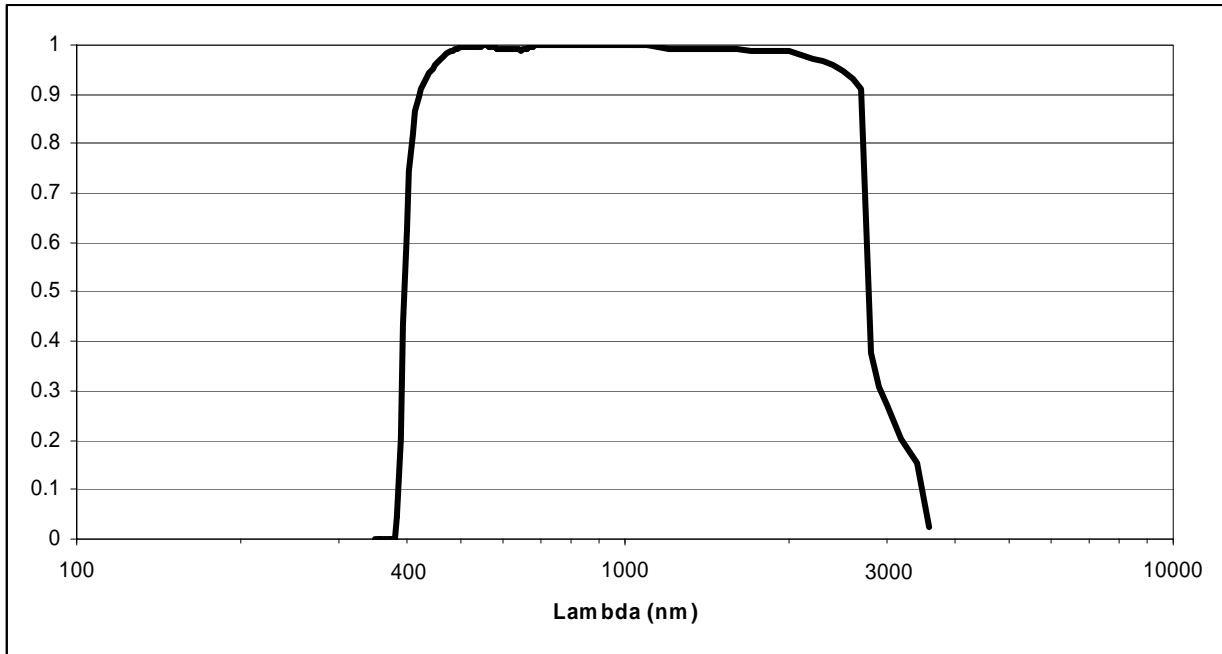

Figure 12: spectral response curve of the pyranometer.

8 SENSOR CALIBRATION

Instruments are factory-calibrated and do not require any additional intervention by users. Each sensor in the HD2402 is individually calibrated in different modes.

Luxmeter (Channel 6), calibration is performed by comparison to the second-line reference luxmeter used at the Delta OHM metrological laboratory; the comparison is performed through an incandescent lamp operating at a color temperature of 2856K (illuminant A).

UV Radiometer (Channel 2), calibration is performed by comparison to the second-line reference radiometer used at the Delta OHM metrological laboratory; calibration is performed with a 270nm monochromatic light obtained at the output of a double monochromator and using a Xe-Hg lamp as a source.

UVA Radiometer (Channel 5), calibration is performed by comparison to the second-line reference radiometer used at the Delta OHM metrological laboratory; calibration is performed with a 365nm monochromatic light obtained by applying a 365nm interferential filter to a Xe-Hg lamp.

BLU Radiometer (Channel 7), calibration is performed by comparison to the second-line reference radiometer used at the Delta OHM metrological laboratory; calibration is performed with a 440nm monochromatic light obtained by applying a 440nm interferential filter to a halogen lamp.

IR Radiometer (Channel 3), calibration is performed by comparison to the second-line reference radiometer used at the Delta OHM metrological laboratory; calibration is performed with a 680nm monochromatic light obtained by applying a 680nm interferential filter to a halogen lamp.

Pyranometer (Channel 9), calibration is performed by comparison to the reference pyranometer by using the light produced by a halogen lamp. Light is perpendicular to the thermopile surface. Calibration is performed in compliance with ISO 9847 ("Calibration of field pyranometers by comparison to a reference pyranometer"), method IIc.

It is recommended to check sensor calibration at least once per year.

9 TECHNICAL SPECIFICATIONS

Instrument

Dimensions (L. x W. x H)	70x70x160 mm 75x75x160 mm with protection sleeve
Weight	500 g
Materials	aluminum alloy rubber protection sleeve

Operating conditions

Operating temperature	-5 ... 50°C
Storage temperature	-25 ... 65°C
Working relative humidity	0 ... 85% RH non condensing

Power supply

Power adapter (code SWD05)	5Vdc/1A
----------------------------	---------

Safety of stored data

unlimited

Serial interface:

output for connection to PC USB input through CP24 cable

Memory capacity

96000 stored data, corresponding to about 26 hours of continuous acquisition.

Storage interval

fixed at 1 second.

MEASUREMENT RANGES

Measurement of illuminance in the spectral range 380÷780 nm

- 0 ÷ 399.9 lux
- 0 ÷ 3.999·10³ lux
- 0 ÷ 39.99·10³ lux
- 0 ÷ 399.9·10³ lux

Measurement of irradiance UV in the spectral range 220÷400 nm with spectral weighting factor S(λ)

- 0 ÷ 39.99·10⁻³ W/m²
- 0 ÷ 399.9·10⁻³ W/m²
- 0 ÷ 3.999 W/m²
- 0 ÷ 39.99 W/m²

Measurement of ultraviolet irradiance in the spectral range UVA (315÷400 nm)

- 0 ÷ 3.999 W/m²
- 0 ÷ 39.99 W/m²
- 0 ÷ 399.9 W/m²
- 0 ÷ 3.999·10³ W/m²

Measurement of irradiance in the spectral range 400÷700 nm (blue) with spectral weighting factor $B(\lambda)$

$$0 \div 399.9 \cdot 10^{-3} \text{ W/m}^2$$

$$0 \div 3.999 \text{ W/m}^2$$

$$0 \div 39.99 \text{ W/m}^2$$

$$0 \div 399.9 \text{ W/m}^2$$

Measurement of infrared irradiance, in the spectral range 700÷1300 nm, with spectral weighting factor $R(\lambda)$

$$0 \div 3.999 \text{ W/m}^2$$

$$0 \div 39.99 \text{ W/m}^2$$

$$0 \div 399.9 \text{ W/m}^2$$

$$0 \div 3.999 \cdot 10^3 \text{ W/m}^2$$

Measurement of infrared irradiance, in the spectral range 400÷2800 nm

$$0 \div 3.999 \cdot 10^3 \text{ W/m}^2$$

10 STORAGE

Instrument storage conditions:

- Temperature: -25...+70°C.
- Humidity: 10...90%RH non condensing.
- In storing, avoid places where:
 - Humidity is at high level.
 - The instrument is exposed to direct sunlight.
 - The instrument is exposed to a high temperature source.
 - There are strong vibrations.
 - The instrument is exposed to vapors, salt and/or corrosive gas.

11 SAFETY INSTRUCTIONS

General safety instructions

This instrument has been constructed and tested in compliance with EN61010-1 safety regulations regarding electronic measuring instruments and left the factory in perfect safety technical conditions.

The regular operation and operational safety of the instrument can be assured only if all normal safety measures are observed, along with the specific measures described in this instruction manual.

The regular operation and operational safety of the instrument can be assured only at the climatic conditions specified in this manual.

Do not use the instrument in places where the following may occur:

- Rapid variations of ambient temperature that may cause condensation.
- Corrosive or inflammable gazes.
- Direct vibrations or shocks to the instrument.
- High-intensity electromagnetic fields, static electricity.

If the instrument is moved from a cold environment to a hot one and vice versa, the formation of condensation may disturb the operation of the unit. In this case, wait till the instrument temperature reaches the ambient temperature before operating the unit.

User obligations

The user of the instrument shall make sure that the following rules and directives concerning hazardous materials are observed:

- CE directives on safety at work
- Local laws on safety at work
- Accident-prevention regulations

12 ORDER CODES

HD2402 Multi-sensor instrument, datalogger for the measurement of non-coherent optical radiations. Provided with: **DeltaLog13** software (**from 1.0.1.0 version**) for data download, monitor and data processing on PC, **CH20-ROA** hardware key for software enabling, **CP24** connection cable, **SWD05** power supply unit, **VTRAP20** tripod, instruction manual, case.

Accessories:

CH20-ROA **Hardware key** for PCs with Windows® operating systems. If connected to the USB port of a PC, enables the use of Delta-Log13 software with HD2402 instrument.

CP24 Connection cable to a PC or power supply, with M12 connector on the instrument side and A-type USB connector on the PC/power supply side.

DeltaLog13 Additional copy of the software for PC connection, for instrument configuration and data download to the PC memory. For Windows® operating systems.

SWD05 **100-240Vac/5Vdc-1A** power supply unit. Output with A-type USB connector.

VTRAP20 Tripod to be attached to the instrument, maximum height 270 mm.

DICHIARAZIONE DI CONFORMITÀ DEL COSTRUTTORE

MANUFACTURER'S DECLARATION OF CONFORMITY

rilasciato da
issued by

DELTA OHM SRL STRUMENTI DI MISURA

DATA 2010/09/28
DATE

Si certifica che gli strumenti sotto riportati hanno superato positivamente tutti i test di produzione e sono conformi alle specifiche, valide alla data del test, riportate nella documentazione tecnica.

We certify that below mentioned instruments have been tested and passed all production tests, confirming compliance with the manufacturer's published specification at the date of the test.

La riferibilità delle misure ai campioni internazionali e nazionali delle unità del SIT è garantita da una catena di riferibilità ininterrotta che ha origine dalla taratura dei campioni di laboratorio presso l'Istituto Primario Nazionale di Ricerca Metrologica.

The traceability of measures assigned to international and national reference samples of SIT units is guaranteed by a uninterrupted reference chain which source is the calibration of laboratories samples at the Primary National Metrological Research Institute.

Tipo Prodotto: Foto-Radiometro Datalogger
Product Type: Photo-Radiometer Datalogger

Nome Prodotto: HD2402
Product Name:

Responsabile Qualità
Head of Quality

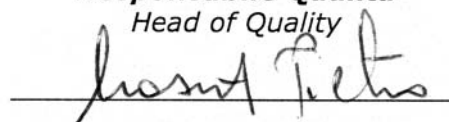

DELTA OHM SRL
35030 Caselle di Selvazzano (PD) Italy
Via Marconi, 5
Tel. +39.0498977150 r.a. - Telefax +39.049635596
Cod. Fisc./P.Iva IT03363960281 - N.Mecc. PD044279
R.E.A. 306030 - ISC. Reg. Soc. 68037/1998

WARRANTY



WARRANTY TERMS

All DELTA OHM instruments are subject to accurate testing, and are guaranteed for 24 months from the date of purchase. DELTA OHM will repair or replace free of charge the parts that shall be deemed non efficient according to its own judgment within the warranty period. Complete replacement is excluded and no damage claims are accepted. DELTA OHM warranty only covers instrument repair. Warranty is void in case of incidental breakage during transport, negligence, misuse, connection to a different voltage than that required for the appliance by the operator. Finally, a product repaired or tampered by unauthorized third parties is excluded from warranty. The instrument shall be returned FREE OF SHIPMENT CHARGES to your dealer. The jurisdiction of Padua applies in any dispute.



The electrical and electronic equipment marked with this symbol cannot be disposed of in public landfills. According to the UE Directive 2002/96/EC, the European users of electrical and electronic equipment can return it to the dealer or manufacturer upon purchase of a new one. The illegal disposal of electrical and electronic equipment is punished with an administrative fine.

This warranty certificate must be sent together with the instrument to our service centre.
IMPORTANT: warranty is valid only if the coupon has been correctly filled in all its parts.

Instrument code **HD2402**

Serial number _____

RENEWALS

Date _____	Date _____
Inspector _____	Inspector _____
Date _____	Date _____
Inspector _____	Inspector _____
Date _____	Date _____
Inspector _____	Inspector _____



CE CONFORMITY	
Safety	EN61000-4-2, EN61010-1 LEVEL 3
Electrostatic discharges	EN61000-4-2 LEVEL 3
Fast electric transients	EN61000-4-4, EN61000-4-5 LEVEL 3
Voltage variations	EN61000-4-11
Electromagnetic interference susceptibility	IEC1000-4-3
Electromagnetic interference emission	EN55022 class B